

**Spring Probes for ATE, Connectors, Batteries, Wire Harnesses,
Semiconductor Packages and General Purpose Applications**



Semiconductor



Board Test



Custom Pogos®

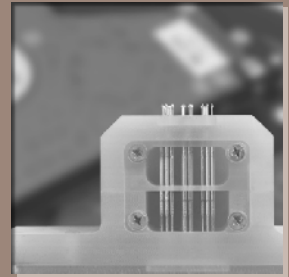
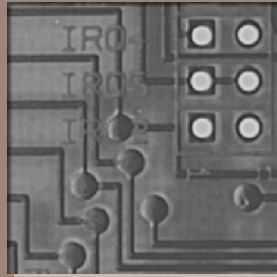
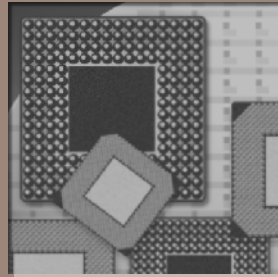

**OSTBY BARTON
POGO® PROBES**



Ostby Barton's Experience... It Works for You

CONTENTS

Technical Data1

Probe Tip Selection3

General Application Probes

<i>Model No.</i>	<i>Test Centers</i>	
IP20	.030 (0,76)	4
IP27	.039 (1,00)	4
IP261	.050 (1,27)	5
IP271	.050 (1,27)	6
POGO-72	.050 (1,27)	7
POGO-1	.075 (1,91)	8
IP40	.075 (1,91)	9
POGO-25	.100 (2,54)	10
DER-50	.050 (1,27)	12
DER-75	.075 (1,91)	12
DER-100	.100 (2,54)	12
LT54	.100 (2,54)	13
IP541	.100 (2,54)	14
MT54	.100 (2,54)	15
MT554	.100 (2,54)	16
IP80	.125 (3,18)	17
IP93	.187 (4,75)	18
IP125	.187 (4,75)	19

High Current Probes

HC80	.125 (3,18)	20
HC93	.187 (4,75)	21
HC125	.187 (4,75)	22

Test System Interface Probes

FRP-25T	.100 (2,54)	23
GSP-2B	.100 (2,54)	23
SIP-90	.100 (2,54)	24
GPP-95-2	.100 (2,54)	24

Semiconductor Probes

CSP4	.016 (0,40)	26
CSP5	.020 (0,50)	26
CSP8	.032 (0,80)	26
CSP1-1.27	.039 (1,00) / .050 (1,27)	26
BGA/PGA/LGA applications	.050 (1,27)	27
Special/Double Ended	Various	28

Tools29

Plating Legend

Plunger plating is color coded for easy reference.

■ Gold plated ■ Gold plated steel



487 Jefferson Boulevard
Warwick, Rhode Island 02886
Tel: (401) 739-7310
Fax: (401) 732-4937
www.ectinfo.com

© Ostby Barton 2003
Pogo is a registered trademark of Everett Charles Technologies. Cyclo-solder, PC, Quick-Connect, Microsharp, PogoPlus, Trident and FASTITE are trademarks of Everett Charles Technologies. All information contained in this document is furnished for the sole purpose of identifying and suggesting the nature of the product involved and does not warrant the nature or quality of the product. ©2003 Everett Charles Technologies, Pomona, CA. All international rights reserved. Everett Charles Technologies products are covered by U.S. and foreign patents and or pat. Pend. Patent Numbers 4,200,351; 4,461,993; 4,720,275; D343802; 5,045,780; 5,447,442; 5,557,213; 5,801,544 and patents pending. Specifications subject to change without notice. Consult Ostby Barton for latest design changes. Dimensions in inches (millimeters).

The Perfect Solution for Your Testing Problem

Test Probe Selection

Whether you are testing bare or loaded, conventional or SMT PCBs, you can maximize your testing efficiency by selecting the correct probe. Probes are manufactured in a combination of sizes (dimensional configurations), tip styles, and spring pressures to meet a variety of testing factors such as test pad geometry, component lead length, hole size, solder mask, and electrical current/resistance rating. In general, probes are divided into two groups – bare board (short stroke probes) and loaded board (long stroke probes). Short stroke probes usually have a full plunger travel of .160" (4,06 mm) or less, while the longer stroke probe is typically .250" (6,35).

Probe Selection & Mixed Test Center Applications

Test Centers	Full Plunger Travel		
	.050 (1,27)	.100 (2,54)	.250 (6,35)
.050 (1,27)	IP271	IP261	Pogo-72
.075 (1,91)	Consult Factory	IP40	Pogo-1
.100 (2,54)	MT54	MT554	Pogo-25

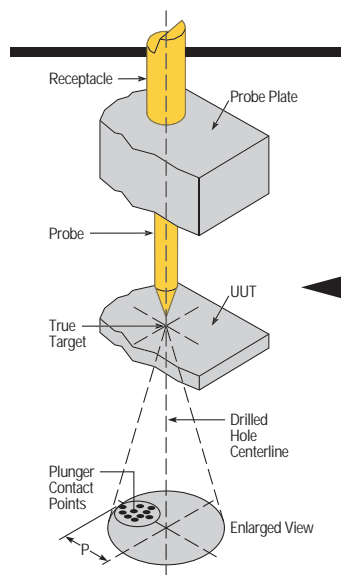

MIXED TEST CENTERS

In some cases, test centers vary on a PCB and you may need to mix probe sizes within a test fixture. This can be accomplished by selecting probes with a similar plunger travel and mounting them accordingly.

SPRING PRESSURE

Most probe series have several spring pressures. Use the light spring pressure in densely populated areas of your vacuum fixture to insure proper actuation. High pressure springs penetrate contamination more effectively, and should be used in low density areas or in mechanically actuated fixtures where vacuum is

Ostby Barton manufactures probes in a combination of sizes (dimensional configurations), tip styles and spring pressures to accommodate a variety of testing factors.

not used. As a rule of thumb, use high pressure when possible. If you can't "pull" a sufficient vacuum on your board, then the spring pressure per sq. inch may exceed atmospheric pressure and a light spring pressure may be needed. Spring forces may be $\pm 20\%$.

SMT Probes

A full line of 50 mil (1,27 mm) center SMT Test Probes are available. These probes are designed for use in applications where probe tip to PCB target accuracy and electrical performance is critical. Look for the "SMT" symbol in this catalog as your guide in selecting a SMT probe.

POINTING ACCURACY (P)

The radial movement of the plunger tip from the centerline of the mounting location is considered the pointing accuracy. The buildup of tolerances between components, as well as the probe design and assembly techniques, dictate the achievable pointing accuracy for a particular probe. While critical to the

success of SMT PCB testing, it is but one consideration in maximizing tip-to-target accuracy. Other factors include fixture and PCB manufacturing tolerances. These include tooling pin alignment, drill hole perpendicularity, probe platen flatness as well as PCB artwork alignment.

PogoPlus® Series probes

Conventional bias-type probes are susceptible to false opens – that is, transient electrical discontinuities that cause good products to "fail" during test. Revolutionary PogoPlus probes eliminate probe-induced false opens, saving you the time,

money and trouble of needless product retesting.

The unrivaled electrical performance of the PogoPlus is due to the interaction between the spring, captured ball and plunger, which forces the plunger into continuous contact with the barrel wall at all times. The result is uninterrupted electrical continuity and low overall resistance that can't be equaled by any other "high performance" probe.

The PogoPlus is also designed to be the world's most durable probe with features like optional stainless-steel MicroSharp™ tips, tough plating, a larger spring volume and enhanced pointing precision.



Receptacles

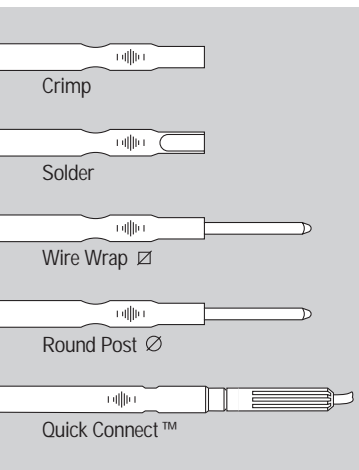

Quick Connect™ Receptacle

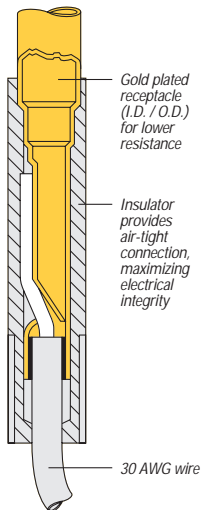

High Current Probes

High current probes can carry 8-35 amps through a circuit. This is especially useful in non PCB test applications. The HC probe series provides low constant electrical resistance and excellent mechanical life on a variety of test centers. The special internal design provides higher current carrying capacity than "similar looking" probes. The stainless steel springs permit use in high temperature applications while their high pressure provides tip-to-target force minimizing constriction resistance.

Cyclo-Soldered Probes

The actuation of your vacuum fixture can pull solder fumes, fluxes, dust and smoke from the air. These elements are then deposited, together with friction-induced plating wear, on the bearing surfaces of your probe. Resistance can then skyrocket from under 50 milliohms to 2-3 ohms. In addition, high resistance readings may be intermittent, which makes it nearly impossible to find and replace the problem probes.

To address this situation, Ostby Barton originated and developed the Cyclo-Soldered test probe. This unique process provides a continuous, metallurgically bonded unit ensuring low and stable electrical constant resistance from one end of the probe to the other. When the bearing surfaces become completely insulated by contaminants, the spring (which is silver soldered to the plunger and barrel) takes over as the path of least resistance and remains constant throughout the probe's life. The maximum probe resistance is limited to that of the spring itself, which is typically under one ohm.

The Cyclo-Soldered process is available on selected probes shown in this catalog. Please consult the factory for more information.

Custom Probes

Ostby Barton has the industry's largest collection of custom probe designs. We had electrical contact design experience even before electrical contacts were adopted for ATE use.

Chances are good that you'll find the solution you need off the shelf. But if your application demands a more unique approach, our engineers will work with you to develop the probe that meets your needs.

Receptacles

Five receptacle styles are available: crimp, solder, wire wrap, round pin, and Quick Connect™. Some styles are only available in certain sizes (see specific probe series). See the TOOLS section for installation tips.

Ostby Barton creates more custom probe designs than anyone else in the industry.

CRIMP

This reliable connection is used primarily on smaller probe sizes in high density applications where wire wrap is not available or in situations where probe plate thickness inhibits the use of wire wrapping. Push-on terminals can also be used and are commercially available from most connector manufacturers.

SOLDER

This termination provides excellent electrical integrity for high reliability applications. It is used primarily in low density situations.

WIRE WRAP

These terminations are strong and provide excellent electrical integrity. It is the most common termination used in ATE fixturing. Connections can be made quickly by skilled technicians. Push-on terminals which fit the standard .025" (0,63 mm) square post can also be used.

ROUND POST

Round Post receptacles with .025" (0,63 mm) diameter posts are used with .100" (2,54 mm) center connectors and/or ribbon cable assemblies for mass termination.

QUICK CONNECT™

Quick Connect termination provides exceptional contact integrity and is available only on SMT receptacles. Connections can be made quickly and wiring mistakes can be corrected easily without damaging the receptacles.

Ordering Information

PROBES

Specify probe series, tip style, and spring force as shown below.

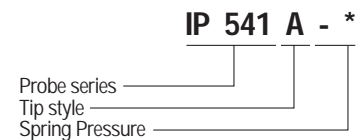

RECEPTACLES

Specify receptacle series and termination method as shown below.

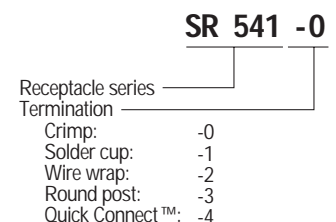

Probe Tip Selection and Applications

More selections to choose from... Ostby Barton.

Most tip styles can be used in a variety of applications. Factors to consider for loaded board tip selection are lead length (bent or straight), cleanliness and pad size. In general, tips with sharp points and internal cutting edges (to trap the lead) such as the crown or tulip, are excellent choices. To penetrate through contamination on bare boards choose a tip with sharp external cutting edges, like the chisel or star tip. These tips may mark the contact surface. As an alternative, use the convex tip on boards which are clean and free of contaminants. Experiment with several different styles until you find the one that works for your application.

A Concave
Long leads, terminals and wire wrap posts.

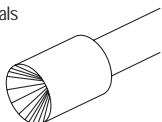

F Flat (headed)
Gold edge fingers. Provides positive contact without leaving any marks or indentations.

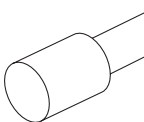

L Crown
Lands, pads, leads. Four sharp points for penetration, self-cleaning.

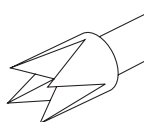

U 3 Point Crown
Lands, pads, leads, holes. Three sharp points for penetration, self-cleaning.



AE Target
Lands, pads, leads, holes. Self-centers on offset leads, for contaminated boards.



G Cup Shaft
Short leads, terminals, wire wrap posts, small-plated holes.

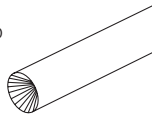

N One-piece Flexi
Contaminated boards, conformal coating. Excellent penetration, flexes for optimum point location.

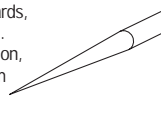

UN Trident
For pads, leads and vias.



B Spear Tip
Lands, pads, plated-through holes. Tool steel holds sharp point, very durable.

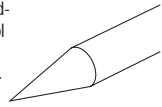

H Serrated
Lands, pads, leads, terminals. Nine points, high current, periodic tip cleaning required.

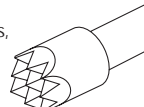

N3 Tri-Needle
Contaminated boards, conformal coating.

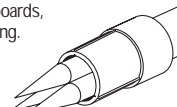

V Tulip
Plated-through holes and short or long component leads, self-cleaning.



C Flat
Gold edge fingers. Provides positive contact without leaving any marks or indentations.

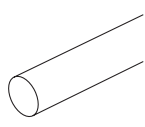

HM HP Receiver Probe



P Star
Plated-through holes, lands, pads. Best contact reliability for holes, self-cleaning.



X Tapered Crown
Lands, pads, leads, holes. Four outer points tapered to lead into hole, self-cleaning.

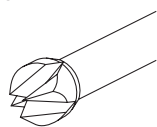

D Spherical Radius (headed)
Gold edge fingers. Provides positive contact without leaving any marks or indentations.

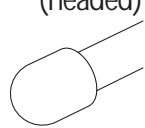

I Pads, vias micro vias



R Ringed Crown .040"
Lands, pads, leads. Four sharp points, ideal for fine line testing, self-cleaning.

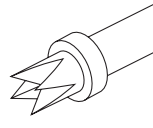

Z Eight Point
Lands, pads, leads. Eight sharp points for penetration, self-cleaning.

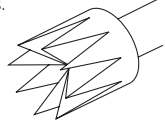

E Convex
Plated-through holes. Use on contamination-free boards, leaves no marks or indentations.

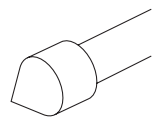

J Spherical Radius
Connectors. Provides positive contact without leaving any marks or indentations.

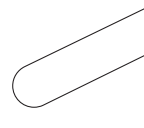

T Chisel
Plated-through holes, test pads, vias

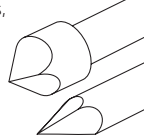

T41, T31, T1

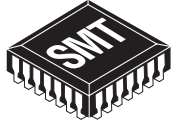

IP20 IP27

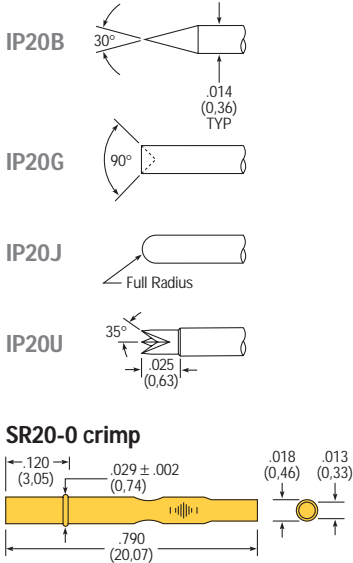
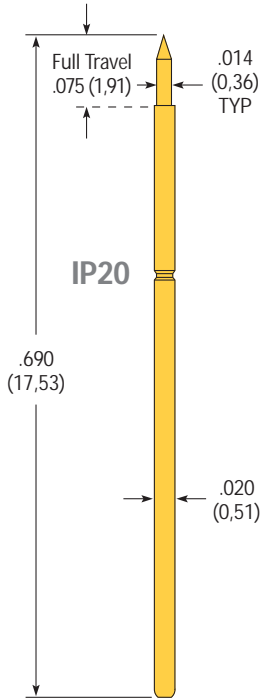

ORDERING INFORMATION:
To order, specify tip style. Example: IP20B is a "B" tip with a standard light spring pressure.

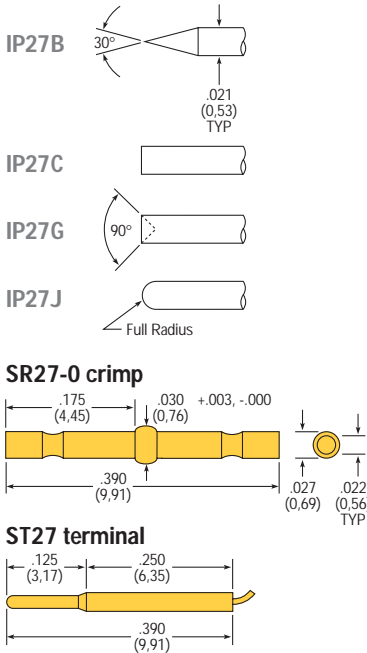
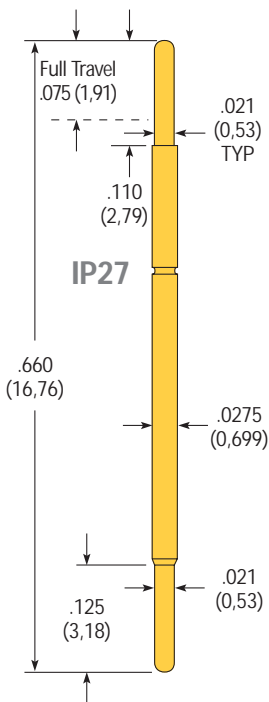

ORDERING INFORMATION:
To order, specify tip style. Example: IP27C is a "C" tip with a standard light spring pressure.

Specifications subject to change without notice.
Drawings not to scale.
Optional tip styles, spring pressures, and materials available, contact factory for more information.

Test Probes for Bare SMT and Substrate Testing

SPECIFICATIONS

PROBE SERIES	IP20	IP27
Test Centers	.030 (0,762)	.039 (1,00)
Mechanical		
Max. Plunger Travel	.075 (1,91)	.075 (1,91)
Recom. Working Travel	.050 (1,27)	.050 (1,27)
Mechanical Life (cycles)	>250,000	>1,000,000
Spring Pressure		
Light: initial	.4 oz. (11g)	.8 oz. (23g)
@ working travel	1.4 oz. (40g)	1.8 oz. (51g)
Materials & Finishes		
Plunger	Hardened Beryllium Copper, Gold plated over Nickel plate	Hardened Beryllium Copper, Gold plated over Nickel plate
Barrel	Hardened Beryllium Copper, Gold plated (I.D. & O.D.) over Nickel plate	Work hardened Nickel Silver, Gold plated (I.D. & O.D.) over Nickel plate
Spring	Music Wire, Silver plated	Stainless Steel, Silver plated
Operating Range (typical)	-55°C to + 105°C	-55°C to + 150°C
Electrical		
Current Rating (static conditions)	2 amps	2 amps
Avg. Resistance (mOHMS)	50	35

RECEPTACLE SERIES	SR20	Uses Insertion Tool #T20-0	SR27	Uses Insertion Tool #T27-0
Mounting Hole Size	.0265/.0276 (0,67/0,70)		.0285/.0295 (0,72/0,75)	
Suggested Drill Size	0,70 mm		#69 or 0,75 mm	
Suggested Wire Gauge	30 AWG		28-30 AWG	
Materials & Finishes	Hardened Beryllium Copper, Gold plated (I.D. & O.D.) over Nickel plate		Work hardened Nickel Silver, Gold plated (I.D. & O.D.) over Nickel plate	
Terminations	Crimp		Crimp, terminal	

Pre-terminated receptacles available, contact factory for information.

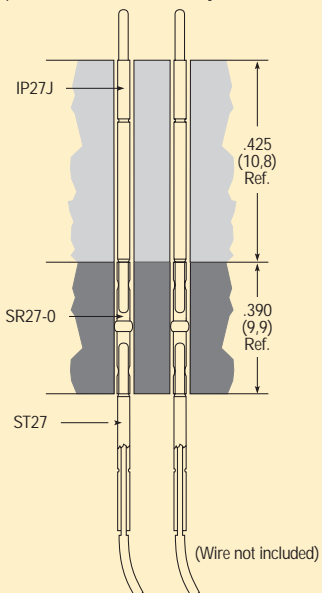

IP261

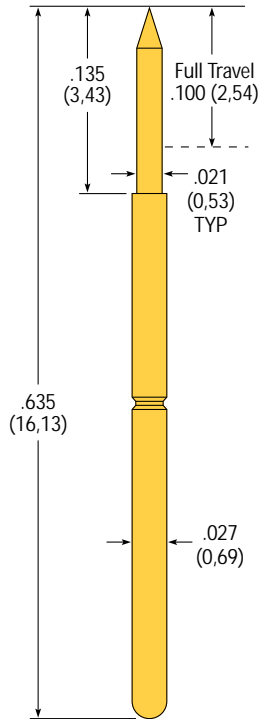
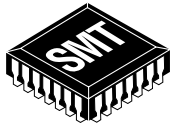

IP261A

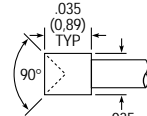

IP261B

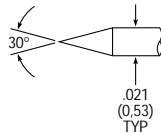

IP261D

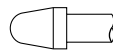

IP261G12

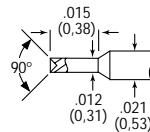

IP261G21

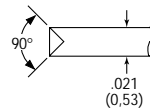

IP261H

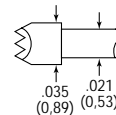

IP261J

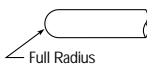

IP261L Self Cleaning

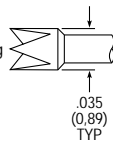

IP261T

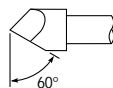

Test Probes for Bare and Loaded SMT PCB Testing

SPECIFICATIONS

PROBE SERIES	IP261
Test Centers	.050 (1,27)
Mechanical	
Max. Plunger Travel	.100 (2,54)
Recom. Working Travel	.067 (1,70)
Mechanical Life (cycles)	>1,000,000
Spring Pressure	
Light: initial	.6 oz. (17g)
@ working travel	2.8 oz. (79g)
Heavy: initial	.8 oz. (23g)
-1 @ working travel	3.7 oz. (105g)
Materials & Finishes	
Plunger	Hardened Beryllium Copper, Gold plated over Nickel plate
Barrel	Work hardened Phosphor Bronze, Gold plated (I.D. & O.D.) over Nickel plate
Spring — light:	Stainless Steel, Silver plated
— heavy:	Music Wire, Silver plated
Operating Range (typical)	Light -55°C to +150°C Heavy -55°C to +105°C
Electrical	
Current Rating (static conditions)	3 amps
Avg. Resistance (mOHMS)	35

RECEPTACLE SERIES	SR261 (Uses Insertion Tool #T261-0)
Mounting Hole Size	.035/.0365 (0,89/0,93)
Suggested Drill Size	#64 or 0,92 mm
Suggested Wire Gauge	28-30 AWG
Materials & Finishes	Work hardened Nickel Silver, Gold plated over Nickel plate
Terminations	Crimp, solder, Quick-Connect™

One RS-1 insulator sleeve is provided with each Quick Connect™ receptacle. Contact factory for price and delivery on additional quantities.

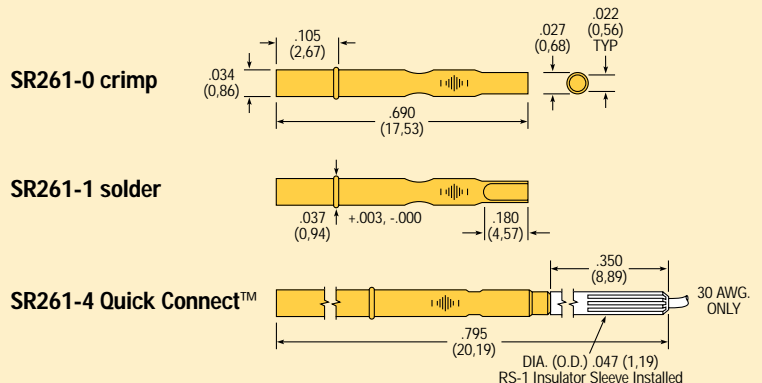

Specifications subject to change without notice.
 Drawings not to scale.
 Optional tip styles, spring pressures, and materials available, contact factory for more information.

ORDERING INFORMATION: To order, specify tip style and spring pressure. Example: IP261A is an "A" tip with a light spring. For a heavy spring pressure, add -1 to the model number, i.e., IP261A-1.

IP271

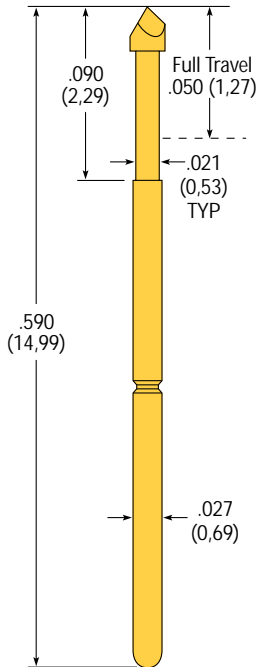
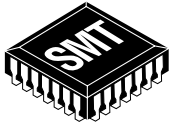

IP271B

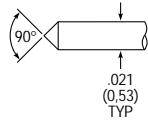

IP271D

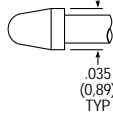

IP271G

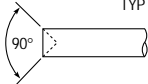

IP271T

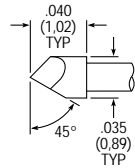

IP271U

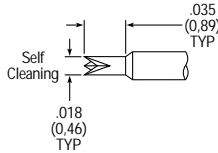

Test Probes for Bare and Loaded SMT PCB Testing

SPECIFICATIONS

PROBE SERIES	IP271
Test Centers	.050 (1,27)
Mechanical	
Max. Plunger Travel	.050 (1,27)
Recom. Working Travel	.050 (1,27)
Mechanical Life (cycles)	>1,000,000
Spring Pressure	
initial	1.6 oz. (45g)
@ working travel	3.2 oz. (91g)
Materials & Finishes	
Plunger	Hardened Beryllium Copper, Gold plated over Nickel plate
Barrel	Work hardened Phosphor Bronze, Gold plated (I.D. & O.D.) over Nickel plate
Spring — light:	Music Wire, Silver plated
Operating Range (typical)	-55°C to + 105°C
Electrical	
Current Rating (static conditions)	3 amps
Avg. Resistance (mOHMS)	35

RECEPTACLE SERIES	SR261 (Uses Insertion Tool #T261-0)
Mounting Hole Size	.035/.0365 (0,89/0,93)
Suggested Drill Size	#64 or 0,92 mm
Suggested Wire Gauge	28-30 AWG
Materials & Finishes	Work hardened Nickel Silver, Gold plated over Nickel plate
Terminations	Crimp, solder, Quick Connect™

One RS-1 insulator sleeve is provided with each Quick Connect™ receptacle. Contact factory for price and delivery on additional quantities.

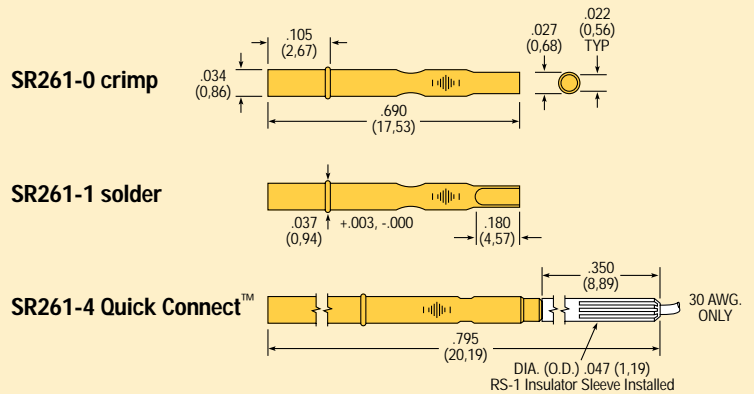

Specifications subject to change without notice.
 Drawings not to scale.
 Optional tip styles, spring pressures, and materials available, contact factory for more information.

ORDERING INFORMATION: To order, specify tip style and spring pressure. Example: IP271B is a "B" tip with a standard spring.

POGO-72

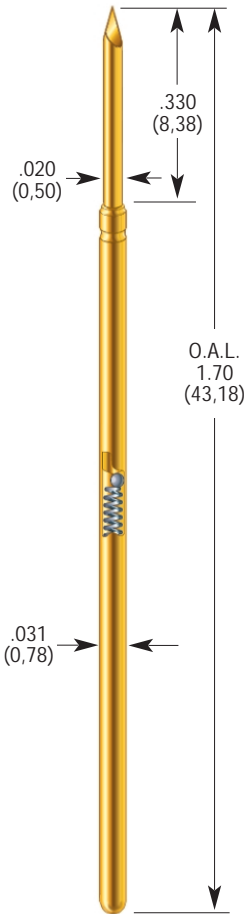
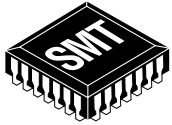

Patented

NOTE: To order in steel, include a -S after model #, i.e. POGO-72H-4-S

Pogo series not available with cyclo-soldered option

POGO-72B

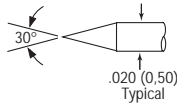

POGO-72H POGO-72H-S

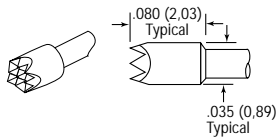

POGO-72J POGO-72J-S

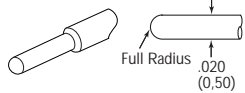

POGO-72T1 POGO-72T1-S

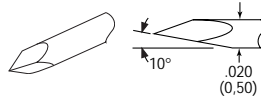

POGO-72T20 POGO-72T20-S

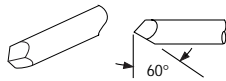

POGO-72T38 POGO-72T38-S

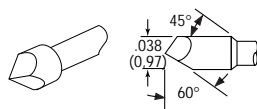

POGO-72U POGO-72U-S

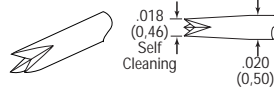

High-Performance Bias Ball Probe For Loaded PCB Testing

SPECIFICATIONS

PROBE SERIES	POGO-72	POGO-72 STEEL
Mechanical		
Full Travel:	.250 (6,35)	.250 (6,35)
Recommended Working Travel:	.167 (4,24)	.167 (4,24)
Mechanical Life Exceeds:	1 x 10 ⁶ cycles	1 x 10 ⁶ cycles
Operating Temperature	-55°C to +105°C	-55°C to +105°C
Consult factory for other temperature requirements, and applications below -40°C		
Electrical (Static Conditions)		
Current Rating:	3 amps	3 amps
maximum continuous current, non-inductive at working travel		
Probe Resistance	15 m Ω	15 m Ω
With a standard deviation of <2 mV @ 25 mA test current		
Materials and Finishes		
Plunger:	Heat-treated beryllium copper, gold-plated over hard nickel	Heat-treated tool steel, gold-plated over hard nickel
Barrel:	Work hardened beryllium copper, HPA-GOLD™ plated (I.D. and O.D.) over hard nickel	Work hardened beryllium copper, HPA-GOLD™ plated (I.D. and O.D.) over hard nickel
Spring:	Music wire	Music wire
Ball:	Stainless steel	Stainless steel

RECEPTACLE SPECIFICATIONS (Uses Insertion Tool #AT31)

Mounting Hole Size:	A #61 drill is most commonly used. .039 (0,99)	
Recommended Wire Gauge:	28-30 AWG	28-30 AWG
Connections:	HPR-72W Crimp (To order with 30 inches of 28 or 30 AWG wire attached, add -28 or -30 to model number.) HPR-72W-1 Solder cup termination (30 AWG only), max. insulation diameter = .019 (0,48), wire strip length = .125 (3,2) HPR-72W-4 FASTITE® wire termination (30 AWG only), max. insulation diameter = .019 (0,48), wire strip length = .125 (3,2) DS-62-1 Insulation sleeve for HPR-72-W-4. One sleeve is provided with each FASTITE® receptacle at no charge. Consult factory for price/delivery on additional quantities. FWA-1-30 30 AWG wire with DS-62-1 insulation sleeve attached.	HPR-72W Crimp (To order with 30 inches of 28 or 30 AWG wire attached, add -28 or -30 to model number.) HPR-72W-1 Solder cup termination (30 AWG only), max. insulation diameter = .019 (0,48), wire strip length = .125 (3,2) HPR-72W-4 FASTITE® wire termination (30 AWG only), max. insulation diameter = .019 (0,48), wire strip length = .125 (3,2) DS-62-1 Insulation sleeve for HPR-72-W-4. One sleeve is provided with each FASTITE® receptacle at no charge. Consult factory for price/delivery on additional quantities. FWA-1-30 30 AWG wire with DS-62-1 insulation sleeve attached.
Materials and Finishes	Work-hardened beryllium copper, HPA-Gold™ plated (I.D. and O.D.) over hard nickel.	Work-hardened beryllium copper, HPA-Gold™ plated (I.D. and O.D.) over hard nickel.

SPRING FORCE +/- 20% IN OZ. (GRAMS)

Spring Type	Preload	2/3 Travel
Light	-2 .73 (21)	2.0 (57)
Standard	as shown -4 .99 (28)	4.0 (114)
Alternate	-6 .64 (18)	6.0 (170)
High	-8 2.33 (66)	8.0 (227)

Optional spring forces and materials are available.

HPR-72W

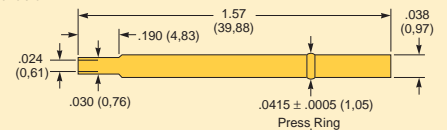

HPR-72W-1



HPR-72W-4

(Shown with DS-62-1 installed)

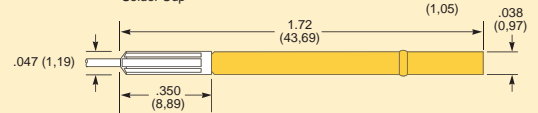

Dimensions in inches (millimeters)



POGO-1

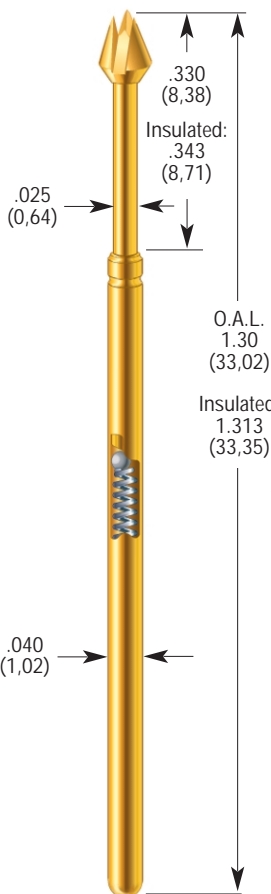
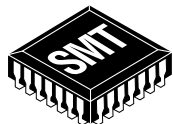

POGO-1A

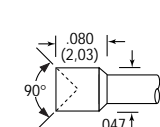

**POGO-1L24
POGO-1L24-S**

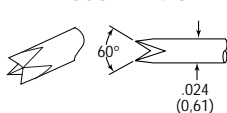

**POGO-1B
POGO-1B-S**

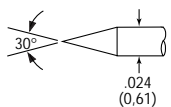

**POGO-1P
POGO-1P-S**

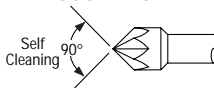

**POGO-1H
POGO-1H-S**

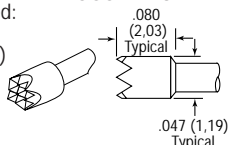

**POGO-1T
POGO-1T-S**

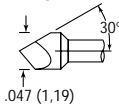

**POGO-1H-INS-8
(Insulated)**

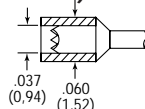

**POGO-1T1
POGO-1T1-S**

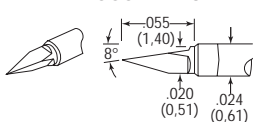

**POGO-1I
POGO-1I-S**

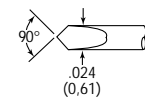

**POGO-1T24
POGO-1T24-S**

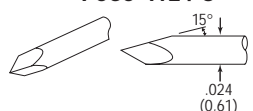

POGO-1I35-S



**POGO-1T30
POGO-1T30-S**

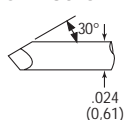

**POGO-1J
POGO-1J-S**

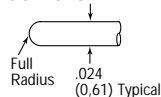

**POGO-1UN
POGO-1UN-S**

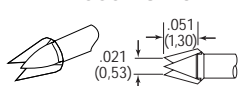

**POGO-1L
POGO-1L-S**

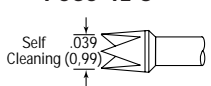

**POGO-1V
POGO-1V-S**

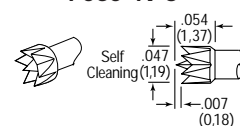

**POGO-1L18
POGO-1L18-S**

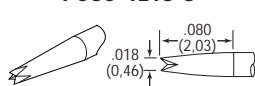

POGO-1Z

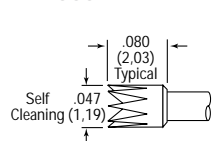

High-Performance Bias Ball Probe For Loaded PCB Testing

SPECIFICATIONS

PROBE SERIES	POGO-1	POGO-1 STEEL
Mechanical		
Full Travel:	.250 (6,35)	.250 (6,35)
Recommended Working Travel:	.167 (4,24)	.167 (4,24)
Mechanical Life Exceeds:	1 x 10 ⁶ cycles	1 x 10 ⁶ cycles
Operating Temperature	-55°C to +105°C Consult factory for other temperature requirements, and applications below -40°C	-55°C to +105°C
Electrical (Static Conditions)		
Current Rating:	6 amps	6 amps
Maximum continuous current, non-inductive at working travel		
Probe Resistance	20 m Ω With a standard deviation of <3 mV @ 25 mA test current	15 m Ω
Materials and Finishes		
Plunger:	Heat-treated beryllium copper, gold-plated over hard nickel	Heat-treated tool steel, gold-plated over hard nickel
Barrel:	Work hardened phosphor bronze, HPA-GOLD™ plated (I.D. and O.D.) over hard nickel	Work hardened phosphor bronze, HPA-GOLD™ plated (I.D. and O.D.) over hard nickel
Spring:	Music wire	Music wire
Ball:	Stainless steel	Stainless steel

RECEPTACLE SPECIFICATIONS (Uses Insertion Tool #ARIT40)

Mounting Hole Size:	.053/.055 (1,35/1,40)	.053/.055 (1,35/1,40)
Suggested Drill Size:	#54 or 1,4 mm	
Recommended Wire Gauge:	24-28 AWG	24-28 AWG
Connections:	LTR-1W Crimp LTR-1W-1 Solder cup LTR-1W-2 Wire wrap/square post. Vacuum leak rate not to exceed 1 x 10 ⁻⁴ CFM @ 15 psi SR40-2L Wire wrap, square post SR40-2LL Wire wrap, square post	LTR-1W Crimp LTR-1W-1 Solder cup LTR-1W-2 Wire wrap/square post. Vacuum leak rate not to exceed 1 x 10 ⁻⁴ CFM @ 15 psi SR40-2L Wire wrap, square post SR40-2LL Wire wrap, square post

Materials and Finishes	Housing:	Work-hardened nickel silver, gold plated over hard nickel	Work-hardened nickel silver, gold plated over hard nickel
Square Post:	Phosphor bronze, gold plated	Phosphor bronze, gold plated	Phosphor bronze, gold plated

SPRING FORCE +/- 20% IN OZ. (GRAMS)

Spring Type	Preload	2/3 Travel
-------------	---------	------------

To order, add dash number to Model Number.

Light	-2	0.72 (20)	2.0 (57)	
Standard	as shown	-4	1.47 (42)	4.0 (114)
Alternate		-6	1.73 (49)	6.0 (170)
High		-8	1.20 (34)	8.0 (227)
Ultra High		-10	3.50 (99)	10.0 (283)

Optional spring forces and materials are available.

LTR-1W

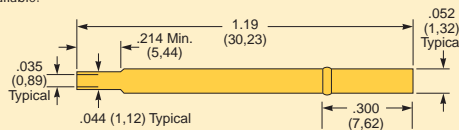

LTR-1W-1

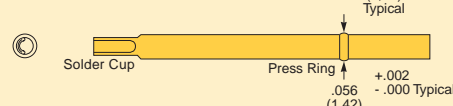

LTR-1W-2

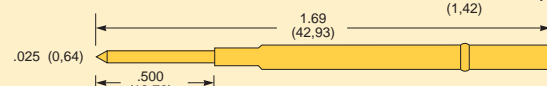

LR40-2L

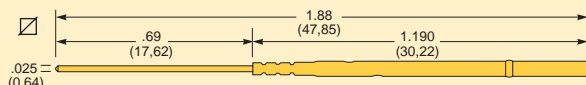

LR40-2LL

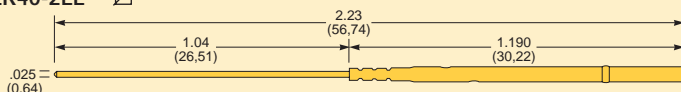

Pogo Plus

IP40

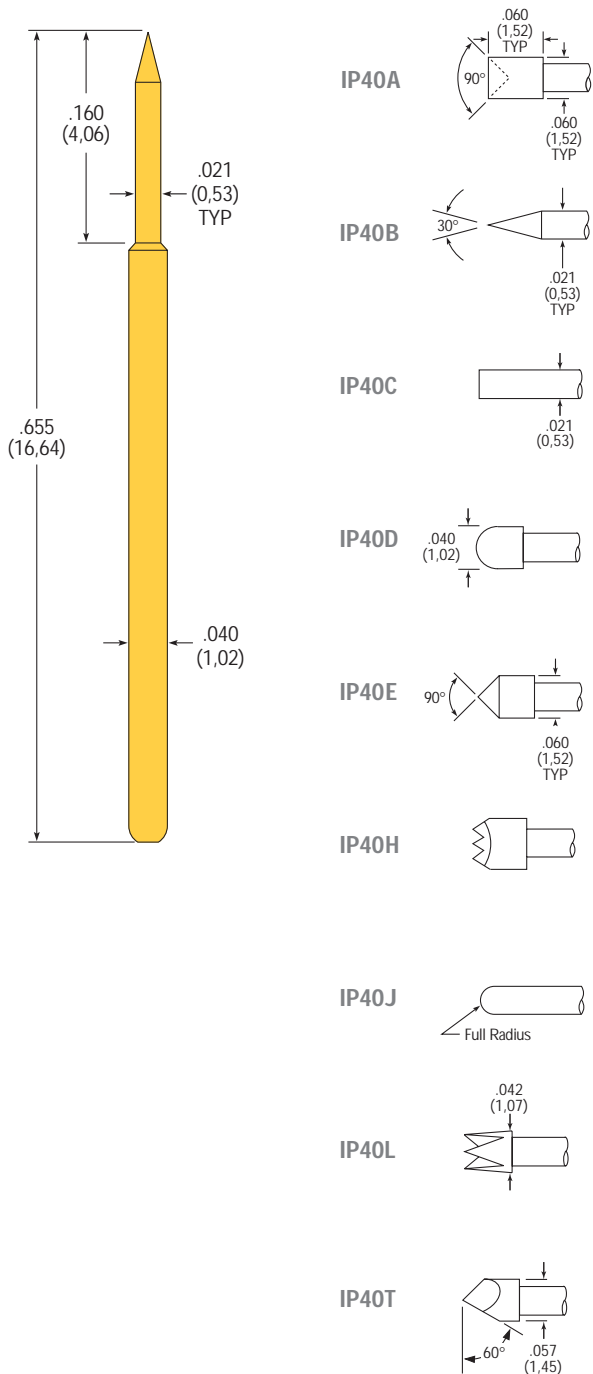

Test Probes for Bare and Loaded PCB Testing

SPECIFICATIONS

PROBE SERIES	IP40
Test Centers	.075 (1,91)
Mechanical	
Max. Plunger Travel	.100 (2,54)
Recom. Working Travel	.067 (1,70)
Mechanical Life (cycles)	>1,000,000
Spring Pressure	
Light: initial	1.1 oz. (31g)
@ working travel	2.5 oz. (71g)
Heavy: initial	1.3 oz. (37g)
-1 @ working travel	4.5 oz. (128g)
Materials & Finishes	
Plunger	Hardened Beryllium Copper, Gold plated over Nickel plate
Barrel	Work hardened Phosphor Bronze, Gold plated (I.D. & O.D.) over Nickel plate
Spring	Stainless Steel, Silver plated
Operating Range (typical)	-55°C to + 150°C
Electrical	
Current Rating (static conditions)	3 amps
Avg. Resistance (mOHMS)	35

RECEPTACLE SERIES	SR40 (Uses Insertion Tool #ARIT40)
Mounting Hole Size	.053/.055 (1,35/1,40)
Suggested Drill Size	#54 or 1,4 mm
Suggested Wire Gauge	24-28 AWG
Materials & Finishes	Work hardened Nickel Silver, Gold plated over Nickel plate
Terminations	Crimp, solder, wire wrap

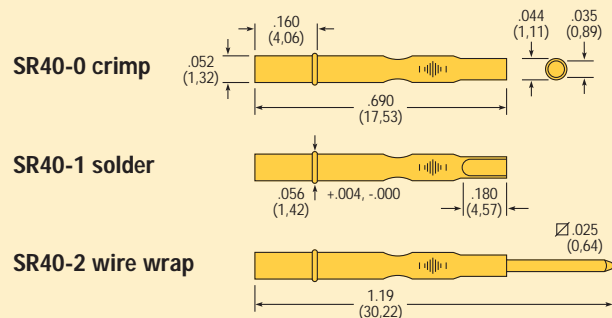

Specifications subject to change without notice.
 Drawings not to scale.
 Optional tip styles, spring pressures, and materials available, contact factory for more information.

ORDERING INFORMATION: To order, specify tip style and spring pressure. Example: IP40A is an "A" tip with a light spring. For a heavy spring pressure, add -1 to the model number, i.e., IP40A-1.

POGO-25

High-Performance Bias Ball Probe For Loaded PCB Testing

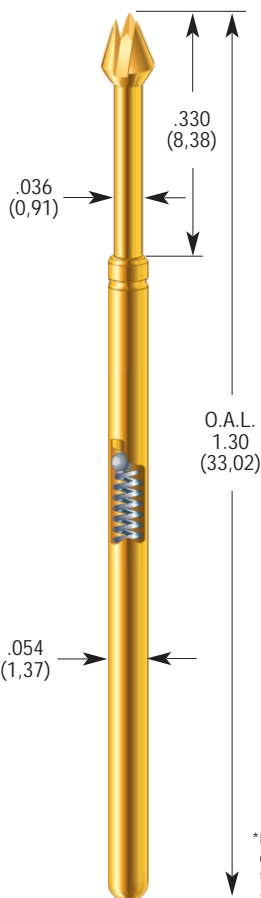

NOTE: To order in steel, include a -S after model #, i.e. POGO-25H-4-S

Pogo series not available with cyclo-soldered option

POGO-25A POGO-25A-S

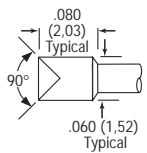

POGO-25B POGO-25B-S

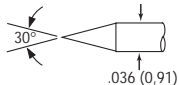

POGO-25FL-S

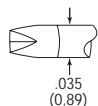

POGO-25H POGO-25H-S



POGO-25H-INS (Insulated)

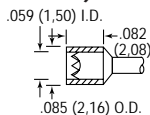

POGO-25HM

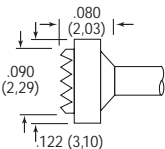

POGO-25HM-INS (Insulated)

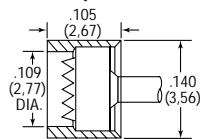

POGO-25I POGO-25I-S

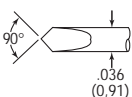

SPECIFICATIONS

PROBE SERIES	POGO-25	POGO-25 STEEL
Mechanical		
Full Travel:	.250 (6,35)	.250 (6,35)
Recommended Working Travel:	.167 (4,24)	.167 (4,24)
Mechanical Life Exceeds:	1 x 10 ⁶ cycles	1 x 10 ⁶ cycles
Operating Temperature	-55°C to +105°C	-55°C to +105°C
Consult factory for other temperature requirements, and applications below -40°C		
Electrical (Static Conditions)		
Current Rating:	10 amps	10 amps
Maximum continuous current, non-inductive at working travel		
Probe Resistance	8 m Ω	8 m Ω
With a standard deviation of <1 mV @ 25 mA test current		
Materials and Finishes		
Plunger:	Heat-treated beryllium copper, gold-plated over hard nickel	Plunger steel, heat-treated tool steel, gold-plated over hard nickel
Barrel:	Work hardened phosphor bronze, HPA-GOLD™ plated (I.D. and O.D.) over hard nickel	Work hardened phosphor bronze, HPA-GOLD™ plated (I.D. and O.D.) over hard nickel
Spring:	Music wire	Music wire
Ball:	Stainless steel	Stainless steel

Insulated and Special Tip Probe Dimensions

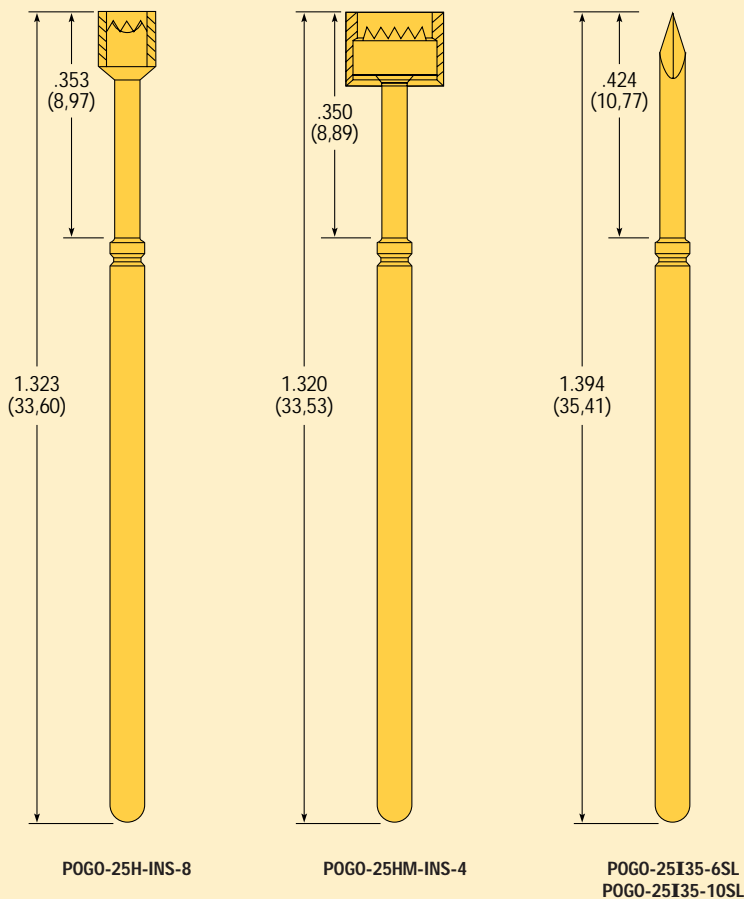

POGO-25I35-S

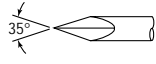

**POGO-25L36
POGO-25L36-S**



**POGO-25I35-6SL*
POGO-25I35-10SL***

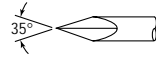

**POGO-25T
POGO-25T-S**

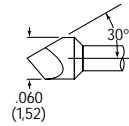

**POGO-25J
POGO-25J-S**

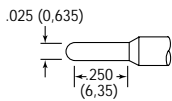

POGO-25T1-S

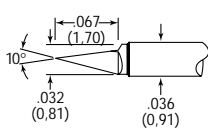

**POGO-25L
POGO-25L-S**

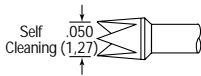

**POGO-25T30
POGO-25T30-S**

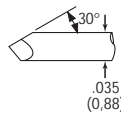

**POGO-25L18
POGO-25L18-S**

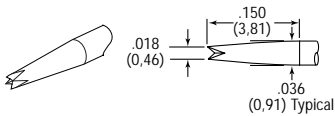

**POGO-25T36
POGO-25T36-S**

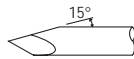

**POGO-25UN
POGO-25UN-S**

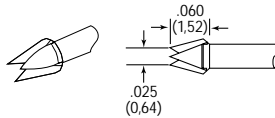

**POGO-25V
POGO-25V-S**

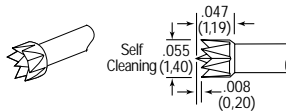

**POGO-25Z
POGO-25Z-S**

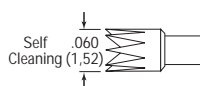

RECEPTACLE SPECIFICATIONS (Uses Insertion Tool #ARIT54)

Mounting Hole Size:	.067/.069 (1,7/1,75)	.067/.069 (1,7/1,75)
Recommended Wire Gauge:	22-26 AWG	22-26 AWG
Connections:	SPR-25W Crimp or push-on termination (AMP terminal 60983-1 or equivalent) SPR-25W-1 Solder cup SPR-25W-2 Wire wrap/square post. Vacuum leak rate not to exceed 1×10^{-4} CFM @ 15 psi SPR-25W-3 Connector pin/round post SR54-2L Wire wrap, square post SR54-2LL Wire wrap, square post	SPR-25W Crimp or push-on termination (AMP terminal 60983-1 or equivalent) SPR-25W-1 Solder cup SPR-25W-2 Wire wrap/square post. Vacuum leak rate not to exceed 1×10^{-4} CFM @ 15 psi SPR-25W-3 Connector pin/round post SR54-2L Wire wrap, square post SR54-2LL Wire wrap, square post

Materials and Finishes

Housing:	Work-hardened nickel silver, gold plated over hard nickel	Work-hardened nickel silver, gold plated over hard nickel
Round Post:	Phosphor bronze, gold plated	Phosphor bronze, gold plated
Square Post:	Phosphor bronze, gold plated	Phosphor bronze, gold plated

SPRING FORCE +/- 20% IN OZ. (GRAMS)

Spring Type	Preload	2/3 Travel
To order, add dash number to Model Number.		
Light	-2 0.70 (20)	2.0 (57)
Standard as shown	-4 1.24 (35)	4.0 (114)
Alternate	-6 1.73 (49)	6.0 (170)
High	-8 2.15 (61)	8.0 (227)
Ultra High	-10 1.87 (53)	10.0 (283)
Super (Available)	-16 3.90 (111)	16.0 (455)

Optional spring forces and materials are available.

SPR-25W

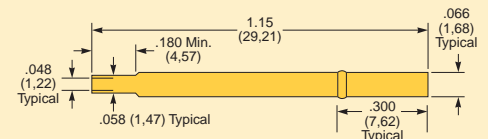

SPR-25W-1

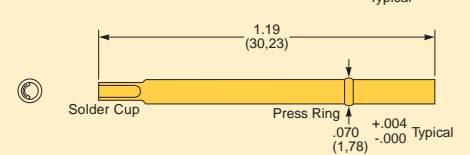

SPR-25W-2 ☒

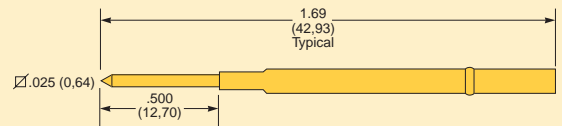

SPR-25W-3 ∅

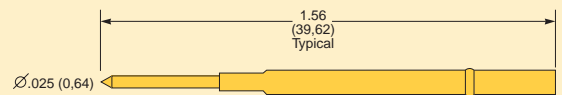

SR54-2L ☒

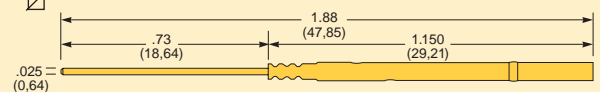

SR54-2LL ☒

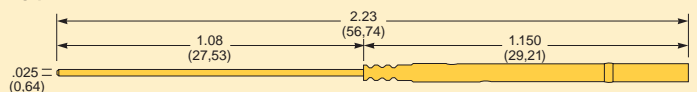

* See diagrams at left for dimensions

DER-50 DER-75 DER-100

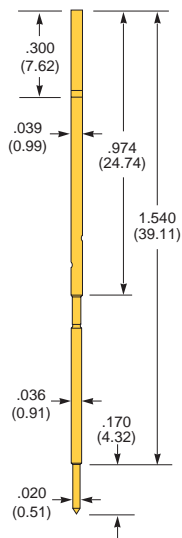

DER-50

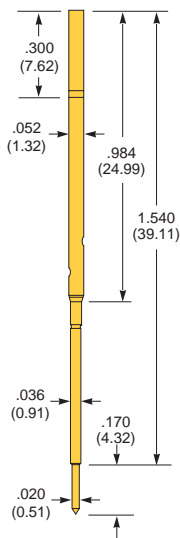

DER-75

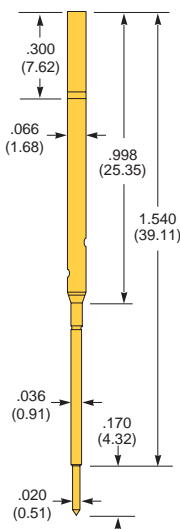

DER-100

B TIP STYLE

Order DER-xxxB-3.5

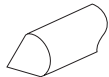

J TIP STYLE

Order DER-xxxJ-3.5

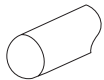

T TIP STYLE

Order DER-xxxT-3.5

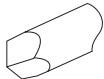

Double-Ended Receptacles

RECEPTACLE SPECIFICATIONS

	DER-050	DER-075	DER-100
Mechanical			
Recommended Mounting Centers:	.050 (1.27)	.075 (1.91)	.100 (2.54)
Full Travel:	.160 (4.06)	.160 (4.06)	.160 (4.06)
Recommended Travel:	.130 (3.30)	.130 (3.30)	.130 (3.30)
Test Height:	1.586 (40.28)	1.586 (40.28)	1.586 (40.28)
Spring Force in oz. (grams):	3.5 (99)	3.5 (99)	3.5 (99)
Overall Length:	1.710 (43.43)	1.710 (43.43)	1.710 (43.43)
Recommended Mounting Hole Size:	.037/.038 (.94/.97)	.053/.055 (1.35/1.40)	.067/.069 (1.70/1.75)
Materials and Finishes			
Plunger:	Beryllium copper alloy, hard gold over nickel	Beryllium copper alloy, hard gold over nickel	Beryllium copper alloy, hard gold over nickel
Barrel:	Beryllium copper alloy, hard gold over nickel	Beryllium copper alloy, hard gold over nickel	Beryllium copper alloy, hard gold over nickel
Spring:	Steel alloy, hard gold over nickel	Steel alloy, hard gold over nickel	Steel alloy, hard gold over nickel
Receptacle:	Beryllium copper alloy, hard gold over nickel	Nickel silver alloy, hard gold over nickel	Nickel silver alloy, hard gold over nickel

Fixture Probes (Ordered Separately)	Pogo-62 (see below)	Pogo-1 (see page 8)	Pogo-25/LT54 (see 10, 11 & 13)
-------------------------------------	---------------------	---------------------	--------------------------------

PROBE SPECIFICATIONS	POGO-62	POGO-62 STEEL
Mechanical		
Full Travel:	.250 (6.35)	.250 (6.35)
Recommended Working Travel:	.167 (4.24)	.167 (4.24)
Mechanical Life:	500,000 cycles	500,000 cycles

Operating Temperature	-55°C to +105°C	-55°C to +105°C
Consult factory for other temperature requirements, and applications below -40° C.		

Electrical (Static Conditions)	3 amps	3 amps
Current Rating:		
Maximum continuous current, non-inductive at working travel		

Probe Resistance	15 mΩ	15 mΩ
With a standard deviation of <1 mΩ @ 25 mA test current		

Materials and Finishes	Heat-treated beryllium copper, hard gold over nickel	Heat-treated beryllium copper, hard gold over nickel
Plunger:		
Barrel:	Work-hardened beryllium copper, hard gold over nickel	Work-hardened beryllium copper, hard gold over nickel
Spring:	Music wire	Music wire
Ball:	Stainless steel	Stainless steel

SPRING FORCE IN OZ. (GRAMS)	Preload	2/3 Travel
Light	-2 .48 (14)	2.0 (57)
Standard	-4 1.02 (29)	4.0 (114)
Alternate	-6 .66 (19)	6.0 (170)

POGO-62

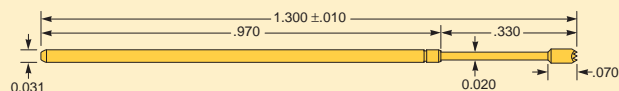

Tip Styles

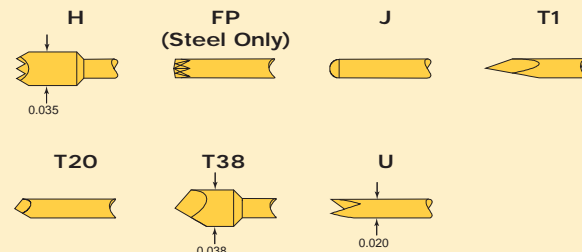

LT54

Long Travel Test Probes for Bare, Loaded and Dual Level PCB Testing

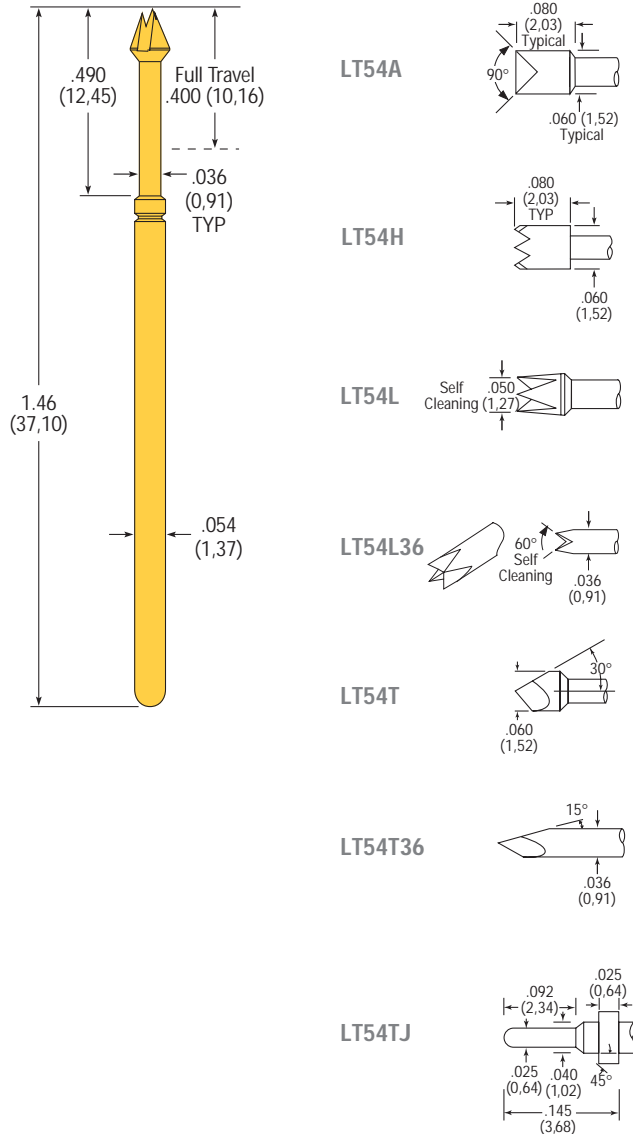

SPECIFICATIONS

PROBE SERIES	LT54	LT54TJ
Test Centers	.100 (2,54)	.100 (2,54)
Mechanical		
Max. Plunger Travel	.400 (10,16)	.345 (8,76)
Recom. Working Travel	.315 (8,0)	.315 (8,00)
Mechanical Life (cycles)	>100,000	>100,000
SPRING FORCE IN OZ. (GRAMS)		
Spring Type	Preload	.315 Travel
Standard	-4	1.24 (35)
Alternate	-6	1.73 (49)
High	-8	2.15 (61)
Materials & Finishes		
Plunger	Hardened Beryllium Copper, Gold plated over Nickel plate	Hardened Beryllium Copper, Gold plated over Nickel plate
Barrel	Work hardened Phosphor Bronze, Gold plated (I.D. & O.D.) over Nickel plate	Work hardened Phosphor Bronze, Gold plated (I.D. & O.D.) over Nickel plate
Spring	Music Wire, Silver plated	Music Wire, Stainless steel
Operating Range (typical)	-55°C to + 105°C	-55°C to + 105°C
Electrical		
Current Rating (static conditions)	10 amps	10 amps
Avg. Resistance (mOHMS)	8	8

RECEPTACLE SERIES	SR54 (Uses Insertion Tool #ARIT54)	SR54 (Uses Insertion Tool #ARIT54)
Mounting Hole Size	.067/.069 (1,70/1,75)	.067/.069 (1,70/1,75)
Suggested Drill Size	1,75 mm	1,75 mm
Suggested Wire Gauge	22-26 AWG	22-26 AWG
Materials & Finishes	Work hardened Nickel Silver, Gold plated over Nickel plate	Work hardened Nickel Silver, Gold plated over Nickel plate
Terminations	Crimp, solder, wire wrap, round post	Crimp, solder, wire wrap, round post

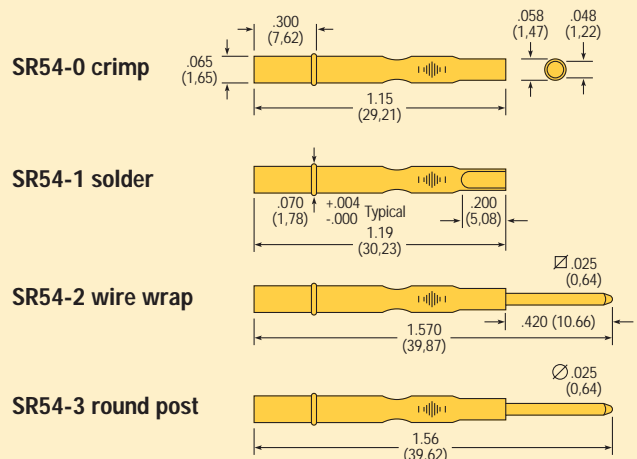

ORDERING INFORMATION: To order, specify tip style and spring pressure. Example: LT54H is an "H" tip with a standard spring.

Specifications subject to change without notice.
 Drawings not to scale.
 Optional tip styles, spring pressures, and materials available, contact factory for more information.

IP541

Test Probes for Bare and Loaded PCB Testing

The IP541 is an interchangeable probe designed for use in testing conventional PCBs.

SPECIFICATIONS

PROBE SERIES	IP541
Test Centers	.100 (2,54)
Mechanical	
Max. Plunger Travel	.160 (4,06)
Recom. Working Travel	.106 (2,69)
Mechanical Life (cycles)	>1,000,000
Spring Pressure	
Light:	initial 1.08 oz. (31g)
	@ working travel 3.5 oz. (99g)
Heavy:	initial 2.64 oz. (75g)
-1	@ working travel 6.5 oz. (184g)
Extra Heavy:	initial 4.09 oz. (116g)
-2	@ working travel 10.0 oz. (283g)
Materials & Finishes	
Plunger	Hardened Beryllium Copper, Gold plated over Nickel, except the K tip which is Tool Steel
Barrel	Work hardened Nickel Silver, Gold plated (I.D. & O.D.) over Nickel plate
Spring	Music Wire, Silver plated
Operating Range (typical)	-55°C to + 105°C
Electrical	
Current Rating (static conditions)	3 amps
Avg. Resistance (mOHMS)	50

RECEPTACLE SERIES	SR541 (Uses Insertion Tool #ARIT54)
Mounting Hole Size	.069 (1,75)
Suggested Drill Size	1,75 mm
Suggested Wire Gauge	22-30 AWG
Materials & Finishes	Work hardened Nickel Silver, Gold plated over Nickel plate
Terminations	Crimp, solder, wire wrap, round post

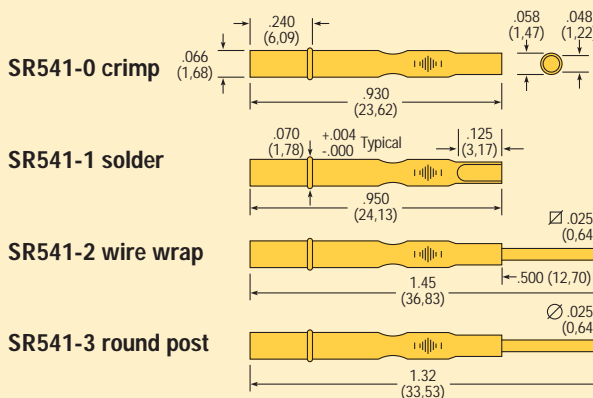
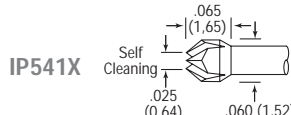
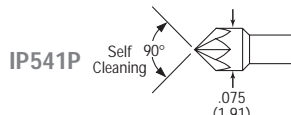
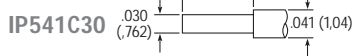
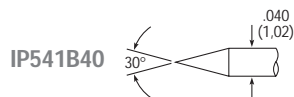
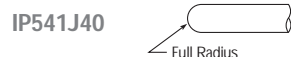
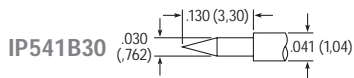
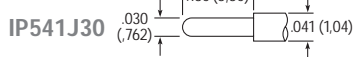
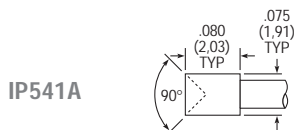
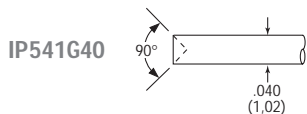
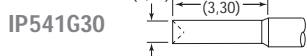
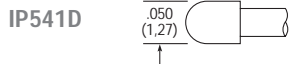
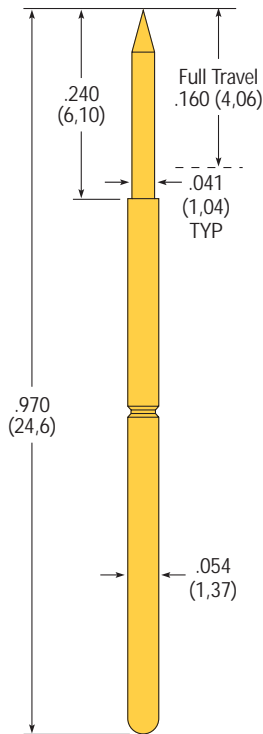

ORDERING INFORMATION: To order, specify tip style and spring pressure. Example: IP541A is an "A" tip with a light spring. For a heavy spring pressure, add -1 to the model number, i.e., IP541A-1.

Specifications subject to change without notice. Drawings not to scale. Optional tip styles, spring pressures, and materials available, contact factory for more information.

MT54

Test Probes for use in Everett Charles Test Equipment Bare PCB Testers

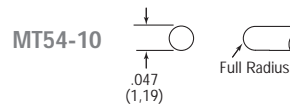
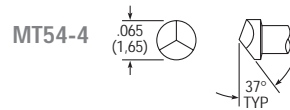
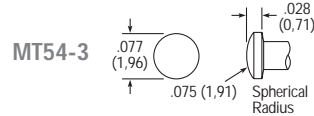
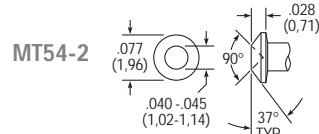
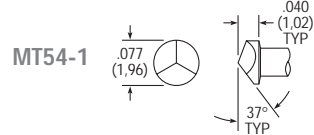
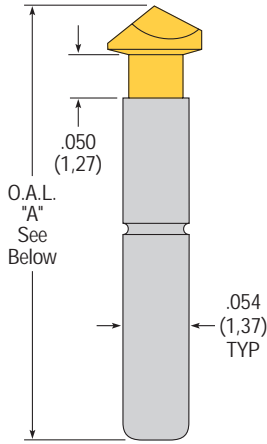

SPECIFICATIONS

PROBE SERIES	MT54
Test Centers	.100 (2,54)
Mechanical	
Max. Plunger Travel	.050 (1,27)
Recom. Working Travel	.050 (1,27)
Mechanical Life (cycles)	>1,000,000
Spring Pressure	
initial	1.1 oz. (31.2g)
@ working travel	3.8 oz. (108g)
Materials & Finishes	
Plunger	Hardened Beryllium Copper, Gold plated over Nickel plate
Barrel	Work hardened Nickel Silver, unplated
Spring	Stainless Steel, Silver plated
Operating Range (typical)	-55°C to + 150°C
Electrical	
Current Rating (static conditions)	3 amps
Avg. Resistance (mOHMS)	50

RECEPTACLE SERIES	MR54 (Uses Insertion Tool #MRT54-005)
Mounting Hole Size	.067/.069 (1,70/1,75)
Suggested Drill Size	1,75 mm
Suggested Wire Gauge	26-30 AWG
Materials & Finishes	Nickel Silver, unplated
Terminations	Wire wrap

MR54-2 wire wrap

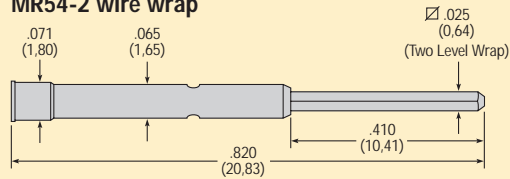

Hole Diameters to be Contacted:	Recommended Test Centers
MT54-1 up to .073 (1,85)	MT54-1, -2, -3, -4, -10 .100 (2,54)
MT54-2 lands and pads	
MT54-3 lands and pads	
MT54-4 up to .058 (1,47)	
MT54-10 lands and pads	

ORDERING INFORMATION: To order, specify model number, i.e., MT54-1.

Model No.	Dimension A
MT54-1, -4	.375 (9,53)
MT54-2, -3	.365 (9,27)
MT54-10	.363 (9,22)

Specifications subject to change without notice.
 Drawings not to scale.
 Optional tip styles, spring pressures, and materials available, contact factory for more information.

MT554

Test Probes for use in Everett Charles Technologies Bare PCB Test Fixtures

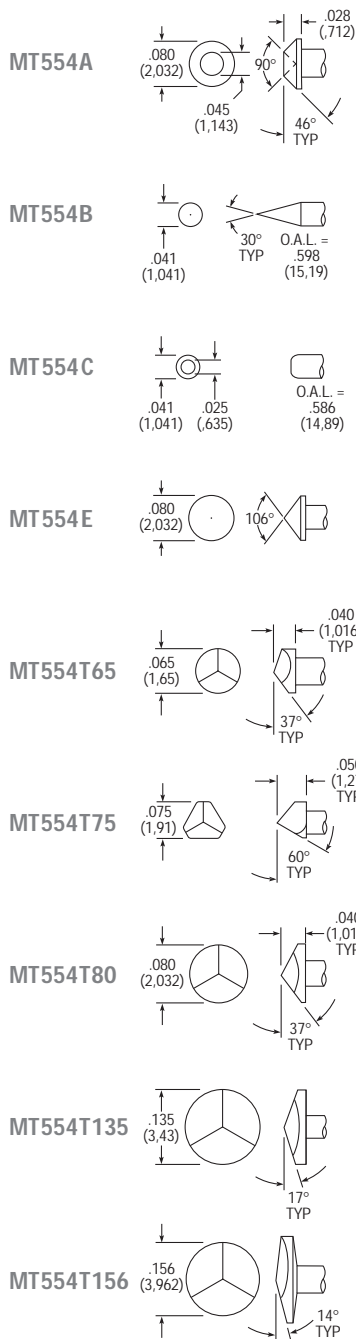
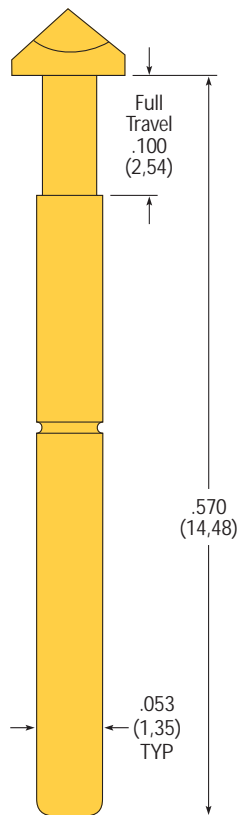

SPECIFICATIONS

PROBE SERIES	MT554
Test Centers	.100 (2,54), .156 (3,96), .187 (4,75)
Mechanical	
Max. Plunger Travel	.100 (2,54)
Recom. Working Travel	.075 (1,91)
Mechanical Life (cycles)	>2,000,000
Spring Pressure	
Light: initial	1.71 oz. (48g)
@ working travel	3.0 oz. (85g)
Heavy: initial	2.82 oz. (79,95g)
-1 @ working travel	5.0 (141g)
Materials & Finishes	
Plunger	Hardened Beryllium Copper, Gold plated over Nickel plate
Barrel	Work hardened Phosphor Bronze, Gold plated (I.D. & O.D.) over Nickel plate
Spring	Stainless Steel, Silver plated
Operating Range (typical)	-55°C to + 150°C
Electrical	
Current Rating (static conditions)	3 amps
Avg. Resistance (mOHMS)	35
RECEPTACLE SERIES	MR554 (Uses Insertion Tool #MRT554-005)
Mounting Hole Size	.067/.069 (1,70/1,75)
Suggested Drill Size	#51 or 1,75 mm
Suggested Wire Gauge	26-30 AWG
Materials & Finishes	Nickel Silver, unplated
Termination	Wire wrap

MR554-2 wire wrap

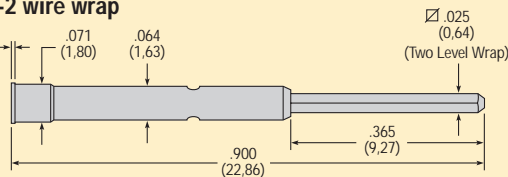

ORDERING INFORMATION: To order, specify tip style and spring pressure. Example: MT554C is a "C" tip with a light spring. For a heavy spring pressure, add -1 to the model number, i.e., MT554C-1.

Hole Diameters to be Contacted:	Recommended Test Centers
MT554A lands and pads	MT554A, B, C, E, T65, T75, T80 .100 (2,54)
MT554B lands and pads	MT554T135 .156 (3,96)
MT554C lands and pads	MT554T156 .187 (4,75)
MT554E up to .073 (1,85)	
MT554T65 up to .058 (1,47)	
MT554T75 up to .070 (1,78)	
MT554T80 up to .073 (1,85)	
MT554T135 up to .125 (3,18)	
MT554T156 up to .150 (3,81)	

Specifications subject to change without notice.
 Drawings not to scale.
 Optional tip styles, spring pressures, and materials available, contact factory for more information.

IP80

Test Probes for General Purpose,
Cable and Harness, Burn-in,
Power Supply, and Connector Testing

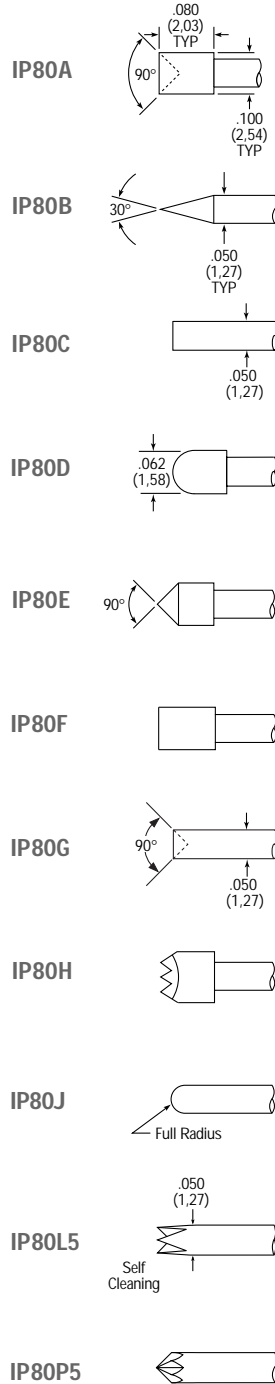
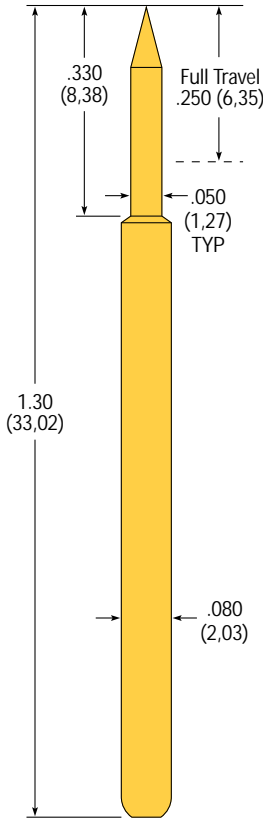

SPECIFICATIONS

PROBE SERIES	IP80
Test Centers	.125 (3,18)
Mechanical	
Max. Plunger Travel	.250 (6,35)
Recom. Working Travel	.166 (4,22)
Mechanical Life (cycles)	>1,000,000
Spring Pressure	
Light: initial	1.6 oz. (51g)
@ working travel	4.5 oz. (128g)
Heavy: initial	2.5 oz. (71g)
-1 @ working travel	6.5 oz. (184g)
Materials & Finishes	
Plunger	Hardened Beryllium Copper, Gold plated over Nickel plate
Barrel	Work hardened Nickel Silver, Gold plated over Nickel plate
Spring — light:	Beryllium Copper, Silver plated
— heavy:	Stainless Steel, Silver plated
Operating Range (typical)	Light -55°C to +105°C or Heavy -55°C to +150°C
Electrical	
Current Rating (static conditions)	6 amps
Avg. Resistance (mOHMS)	50

RECEPTACLE SERIES	SR80 (Uses Insertion Tool #T80-0)
Mounting Hole Size	.094/.096 (2,39/2,44)
Suggested Drill Size	#41 or 2,4 mm
Suggested Wire Gauge	22-26 AWG*
Materials & Finishes	Work hardened Nickel Silver, Gold plated over Nickel plate
Terminations	Crimp, solder, wire wrap

*22-26 AWG wire is recommended only for typical ATE applications. Other applications may require a larger wire size. Contact factory for more information.

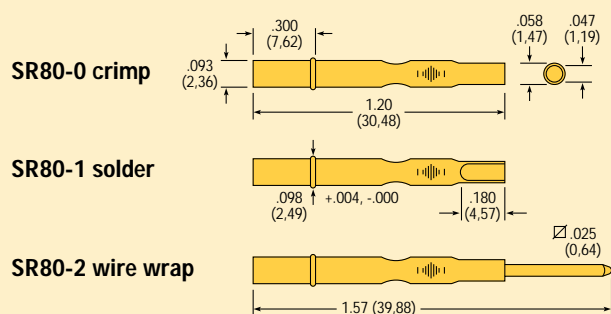

Specifications subject to change without notice.
Drawings not to scale.
Optional tip styles, spring pressures, and materials available, contact factory for more information.

ORDERING INFORMATION: To order, specify tip style and spring pressure. Example: IP80A is an "A" tip with a light spring. For a heavy spring pressure, add -1 to the model number, i.e., IP80A-1.

IP93

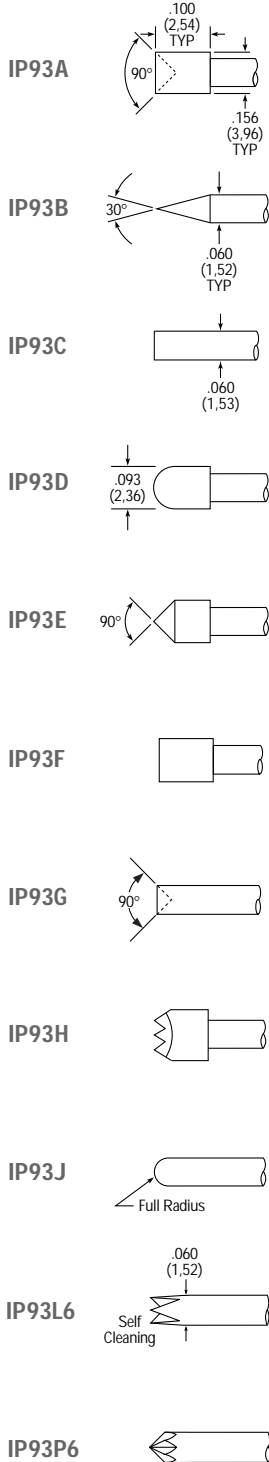
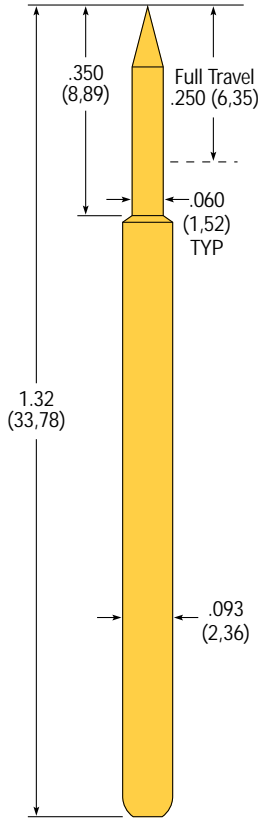

Specifications subject to change without notice.
 Drawings not to scale.
 Optional tip styles, spring pressures, and materials available, contact factory for more information.

Test Probes for General Purpose, Cable and Harness, Burn-in, Power Supply, and Connector Testing

SPECIFICATIONS

PROBE SERIES	IP93
Test Centers	.187 (4,75)
Mechanical	
Max. Plunger Travel	.250 (6,35)
Recom. Working Travel	.166 (4,22)
Mechanical Life (cycles)	>1,000,000
Spring Pressure	
Light: initial	2.2 oz. (62g)
@ working travel	4.8 oz. (136g)
Heavy: initial	3.2 oz. (91g)
-1 @ working travel	6.9 oz. (196g)
Materials & Finishes	
Plunger	Hardened Beryllium Copper, Gold plated over Nickel
Barrel	Work hardened Nickel Silver, Gold plated over Nickel plate
Spring — light:	Beryllium Copper, Silver plated
— heavy:	Stainless Steel, Silver plated
Operating Range (typical)	Light -55°C to +105°C or Heavy -55°C to +150°C
Electrical	
Current Rating (static conditions)	7 amps
Avg. Resistance (mOHMS)	50

RECEPTACLE SERIES	SR93 (Uses Insertion Tool #T93-0)
Mounting Hole Size	.107/.109 (2,72/2,77)
Suggested Drill Size	2,75 mm
Suggested Wire Gauge	22-26 AWG*
Materials & Finishes	Work hardened Nickel Silver, Gold plated over Nickel plate
Terminations	Crimp, solder, wire wrap

* 22-26 AWG wire is recommended only for typical ATE applications. Other applications may require a larger wire size. Contact factory for more information.

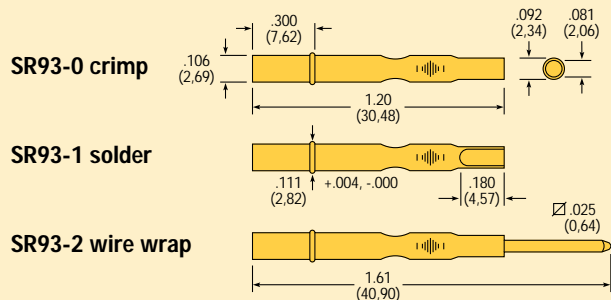

ORDERING INFORMATION: To order, specify tip style and spring pressure. Example: IP93A is an "A" tip with a light spring. For a heavy spring pressure, add -1 to the model number, i.e., IP93A-1.

IP125

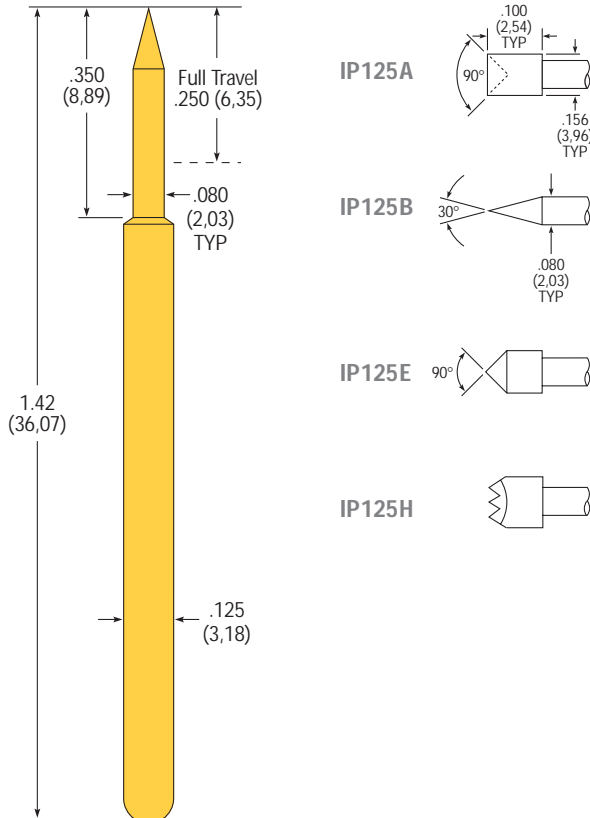

Test Probes for General Purpose, Cable and Harness, Burn-in, Power Supply, and Connector Testing

SPECIFICATIONS

PROBE SERIES	IP125
Test Centers	.187 (4,75)
Mechanical	
Max. Plunger Travel	.250 (6,35)
Recom. Working Travel	.166 (4,22)
Mechanical Life (cycles)	>1,000,000
Spring Pressure	
initial	6.1 oz. (173g)
@ working travel	16.0 oz. (454g)
Materials & Finishes	
Plunger	Hardened Beryllium Copper, Gold plated over Nickel plate
Barrel	Work hardened Nickel Silver, Gold plated over Nickel plate
Spring	Stainless Steel
Operating Range (typical)	-55°C to + 150°C
Electrical	
Current Rating (static conditions)	8 amps
Avg. Resistance (mOHMS)	50

RECEPTACLE SERIES	SR125 (Uses Insertion Tool #T125-0)
Mounting Hole Size	.141/.143 (3,58/3,63)
Suggested Drill Size	3,6 mm
Suggested Wire Gauge	22-26 AWG*
Materials & Finishes	Work hardened Nickel Silver, Gold plated over Nickel plate
Terminations	Crimp, solder, wire wrap

*22-26 AWG wire is recommended only for typical ATE applications. Other applications may require a larger wire size. Contact factory for more information.

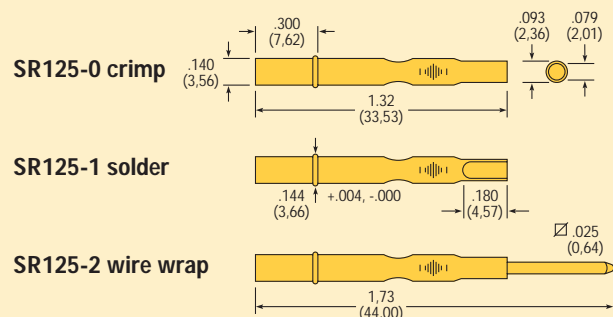

Specifications subject to change without notice.
 Drawings not to scale.
 Optional tip styles, spring pressures, and materials available, contact factory for more information.

ORDERING INFORMATION: To order, specify tip style. Example: IP125A is an "A" tip with a standard spring.

HC80

Test Probes for **HIGH CURRENT** and **HIGH TEMPERATURE** Applications

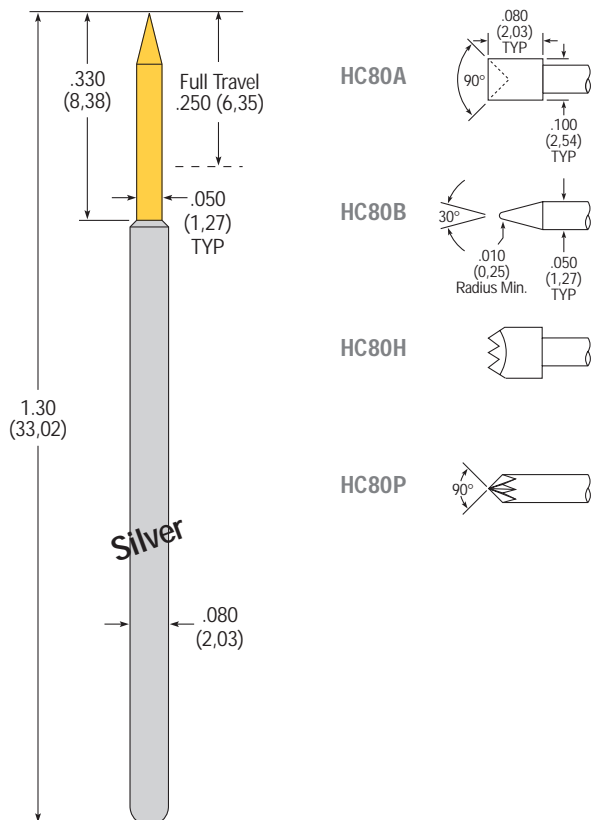

SPECIFICATIONS

PROBE SERIES	HC80
Test Centers	.125 (3,18)
Mechanical	
Max. Plunger Travel	.250 (6,35)
Recom. Working Travel	.166 (4,22)
Mechanical Life (cycles)	>250,000
Spring Pressure	
initial	1.54 oz. (44g)
@ working travel	4.5 oz. (128g)
Materials & Finishes	
Plunger	Hardened Beryllium Copper, Gold plated over Nickel plate
Barrel	Work hardened Nickel Silver, Silver plated (I.D. & O.D.) over Nickel Silver
Spring	Stainless Steel, Silver plated
Operating Range (typical)	-55°C to + 150°C
Electrical	
Current Rating (static conditions)	15 amps (continuous current ambient temp.)
Avg. Resistance (mOHMS)	25

RECEPTACLE SERIES	SR80 (Uses Insertion Tool #T80-0)
Mounting Hole Size	.094/.096 (2,39/2,44)
Suggested Drill Size	#41 or 2,4 mm
Suggested Wire Gauge	22-26 AWG*
Materials & Finishes	Work hardened Nickel Silver, Gold plated over Nickel plate
Terminations	Crimp, solder, wire wrap

*22-26 AWG wire is recommended only for typical ATE applications. Other applications may require a larger wire size. Contact factory for more information.

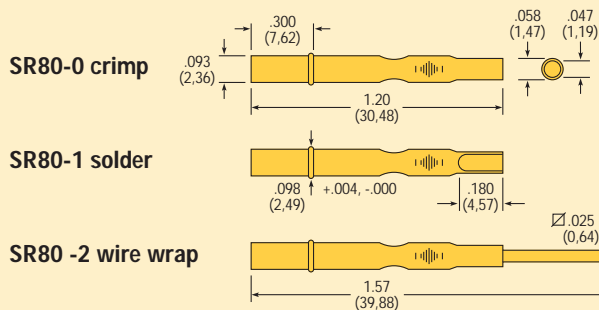

ORDERING INFORMATION: To order, specify tip style. Example: HC80A is an "A" tip with a standard spring pressure.

Specifications subject to change without notice.
 Drawings not to scale.
 Optional tip styles, spring pressures, and materials available, contact factory for more information.

HC93

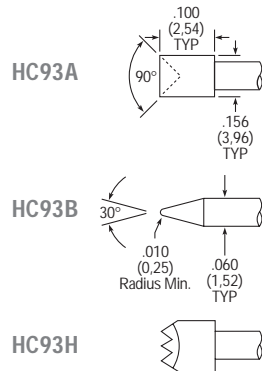
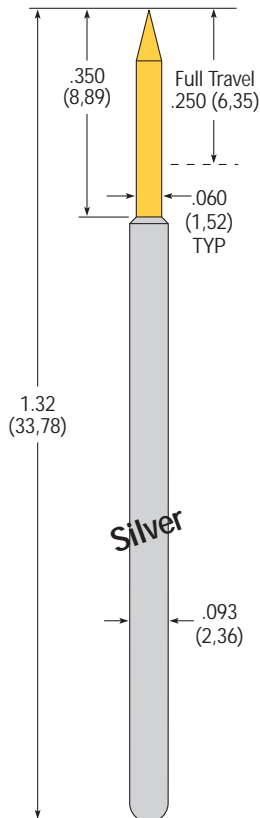

Test Probes for *HIGH CURRENT* and *HIGH TEMPERATURE* Applications

SPECIFICATIONS

PROBE SERIES	HC93
Test Centers	.187 (4,75)
Mechanical	
Max. Plunger Travel	.250 (6,35)
Recom. Working Travel	.166 (4,22)
Mechanical Life (cycles)	>250,000
Spring Pressure	
initial	0.86 oz. (24g)
@ working travel	4.8 oz. (136g)
Materials & Finishes	
Plunger	Hardened Beryllium Copper, Gold plated over Nickel plate
Barrel	Work hardened Nickel Silver, Silver plated (I.D. & O.D.) over Nickel Silver
Spring	Stainless Steel, Silver plated
Operating Range (typical)	-55°C to + 150°C
Electrical	
Current Rating (static conditions)	25 amps (continuous current ambient temp.)
Avg. Resistance (mOHMS)	25

RECEPTACLE SERIES	SR93 (Uses Insertion Tool #T93-0)
Mounting Hole Size	.107/.109 (2,72/2,77)
Suggested Drill Size	2,75 mm
Suggested Wire Gauge	22-26 AWG*
Materials & Finishes	Work hardened Nickel Silver, Gold plated over Nickel plate
Terminations	Crimp, solder, wire wrap

*22-26 AWG wire is recommended only for typical ATE applications. Other applications may require a larger wire size. Contact factory for more information.

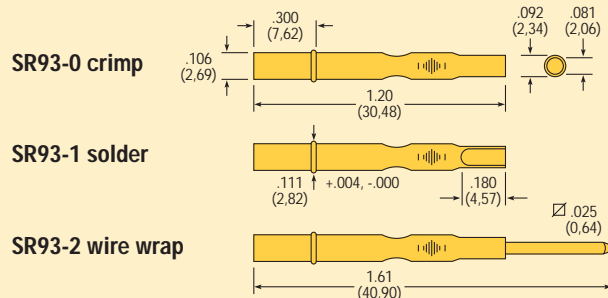

Specifications subject to change without notice.
 Drawings not to scale.
 Optional tip styles, spring pressures, and materials available, contact factory for more information.

ORDERING INFORMATION: To order, specify tip style. Example: HC93A is an "A" tip with a standard spring.

HC125

Test Probes for **HIGH CURRENT** and **HIGH TEMPERATURE** Applications

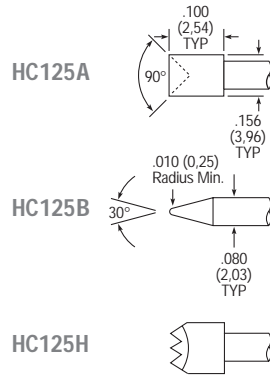
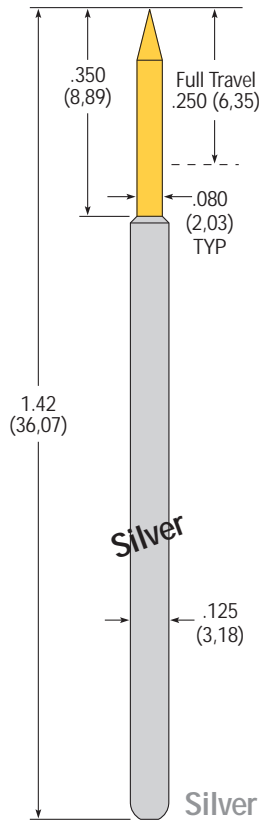

SPECIFICATIONS

PROBE SERIES	HC125
Test Centers	.187 (4,75)
Mechanical	
Max. Plunger Travel	.250 (6,35)
Recom. Working Travel	.166 (4,22)
Mechanical Life (cycles)	>250,000
Spring Pressure	
initial	3.76 oz. (107g)
@ working travel	16.0 oz. (456g)
Materials & Finishes	
Plunger	Hardened Beryllium Copper, Gold plated over Nickel plate
Barrel	Work hardened Nickel Silver, Silver plated (I.D. & O.D.) over Nickel Silver
Spring	Stainless Steel, Silver plated
Operating Range (typical)	-55°C to + 150°C
Electrical	
Current Rating (static conditions)	35 amps (continuous current ambient temp.)
Avg. Resistance (mOHMS)	25

RECEPTACLE SERIES	SR125 (Uses Insertion Tool #T125-0)
Mounting Hole Size	.141/.143 (3,58/3,63)
Suggested Drill Size	3,6 mm
Suggested Wire Gauge	22-26 AWG*
Materials & Finishes	Work hardened Nickel Silver, Gold plated over Nickel plate
Terminations	Crimp, solder, wire wrap

*22-26 AWG wire is recommended only for typical ATE applications. Other applications may require a larger wire size. Contact factory for more information.

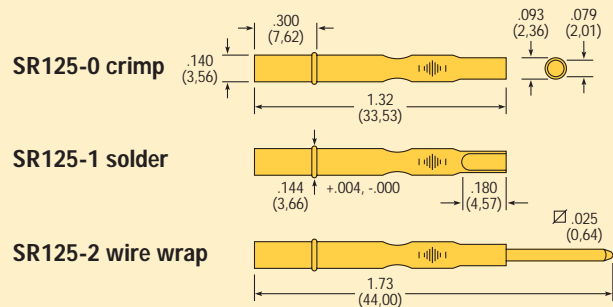

ORDERING INFORMATION: To order, specify tip style. Example: HC125A is an "A" tip with a standard spring pressure.

Specifications subject to change without notice. Drawings not to scale. Optional tip styles, spring pressures, and materials available, contact factory for more information.

FRP-25T GSP-2B

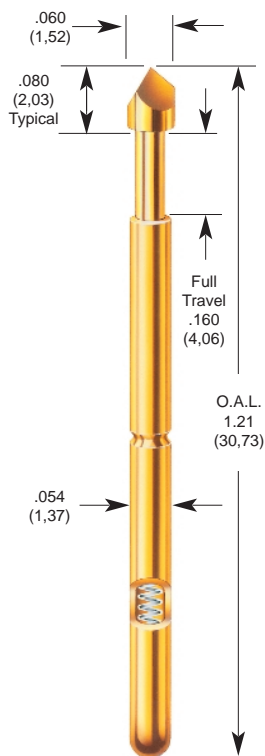

For Factron Series 300/700
FRP-25T

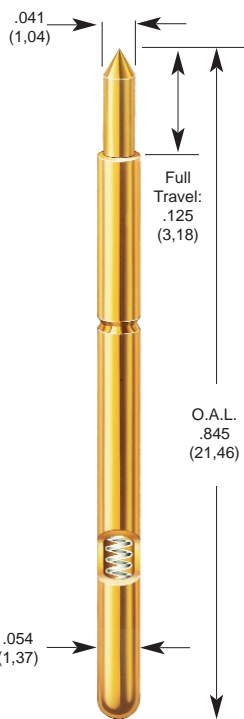

For GenRad 227/82/73
GSP-2B

Note: The GSP-2BP is designed for use in receptacles without detents.

ATE Receiver Probes

SPECIFICATIONS

PROBE SERIES	FRP-25T	GSP-2B
Application:	The FRP-25T is designed for use in Schlumberger (Factron) tester interfaces	The GSP-2B is designed for use in GenRad tester interfaces
Mechanical Full Travel:	.160 (4,06)	.125 (3,18)
Operating Temperature:	-55°C to +105°C Consult factory for other temperature requirements, and applications below -40°C	-55°C to + 130°C
Electrical (Static Conditions) Current Rating: Maximum continuous current, non-inductive at working travel	5 amps	5 amps
Probe Resistance:	35 mΩ With a standard deviation of <5 mΩ @ 25 mA test current	35 mΩ
Materials and Finishes Plunger:	Heat-treated beryllium copper, gold plated over hard nickel	Heat-treated beryllium copper, gold plated over hard nickel
Barrel:	Work-hardened phosphor bronze, gold plated over hard nickel	Work-hardened nickel silver, gold plated (I.D. and O.D.) over hard nickel
Spring:	Music wire, gold plated	Beryllium copper, silver plated

RECEPTACLE SPECIFICATIONS (Uses Insertion Tool #ARIT54)

Materials and Finishes	FRP-25T	GSP-2B
Housing:	Work-hardened nickel silver, gold plated over hard nickel	Work-hardened nickel silver, gold plated over hard nickel
Round Post:	Phosphor bronze, gold plated	Phosphor bronze, gold plated
Square Post:	Phosphor bronze, gold plated	Phosphor bronze, gold plated

SPRING FORCE +/- 20% IN OZ. (GRAMS)

Spring Type	Preload	3/4 Travel
FRP-25T as shown	.92 (26)	4.0 (113)
GSP-2B as shown	2.0 (57)	4.5 (128)

Optional spring forces and materials are available.

W

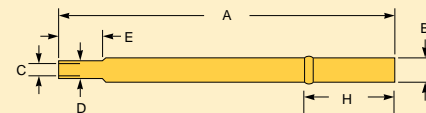

W-1



W-2 \square W-3 \circ

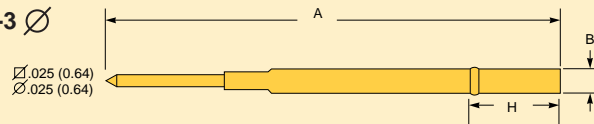

Y

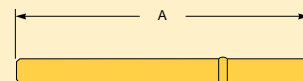

Receptacle Dimensions

	A	B	C	D	E
SPR-25W	1.15(29,21)	.066(1,68)	.048(1,22)	.058(1,47)	.180(4,57)
SPR-25W-1	1.19(30,23)	.066(1,68)	.048(1,22)	.058(1,47)	.180(4,57)
SPR-25W-2	1.69(42,93)	.066(1,68)	Square Post = .025(0,64)		
SPR-25W-3	1.56(39,62)	.066(1,68)	Round Post = .025(0,64) DIA.		
SPR-2W	.930(23,62)	.066(1,68)	.048(1,22)	.058(1,47)	.20(5,08)
SPR-2W-1	.950(24,13)	.066(1,68)	.048(1,22)	.058(1,47)	.20(5,08)
SPR-2W-2	1.45(36,83)	.066(1,68)	Square Post = .025(0,64)		
SPR-2W-3	1.32(33,53)	.066(1,68)	Round Post = .025(0,64) DIA.		
SPR-2Y	.735(18,67)	.066(1,68)			

SPR-25 and SPR-2 Series press ring diameter is typically .070 (1,78)
H dimension SPR-25 Series = .300 (7,62) and SPR-2 Series = .240 (6,09)

SIP-90 GPP-95-2

ATE Interface Pins

GPP-95-2

Materials: Brass, gold plated
 Mounting Hole Size: .085 (2,15)
 Applications: Designed for use in original GenRad interface boards.

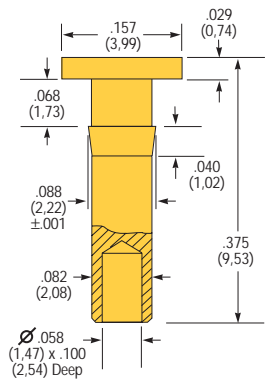

SIP-90-2

Materials: Brass, gold plated
 Mounting Hole Size: .055 (1,40)
 Applications: Designed for use in original GenRad interface blocks.

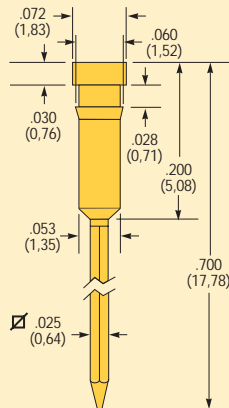

SIP-90-3

Materials: Brass, gold plated
 Mounting Hole Size: .055 (1,40)
 Applications: Designed for use in original Zehntel interface panels.

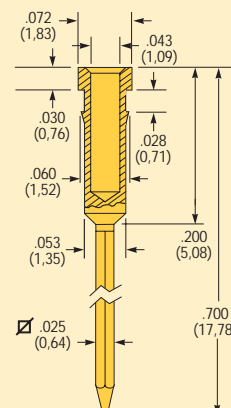

SIP-90-4

Materials: Brass, gold plated
 Mounting Hole Size: .055 (1,40)
 Applications: Designed for use in original Factorion interface panels. SIP-90-4 replaces SIP-90-1.

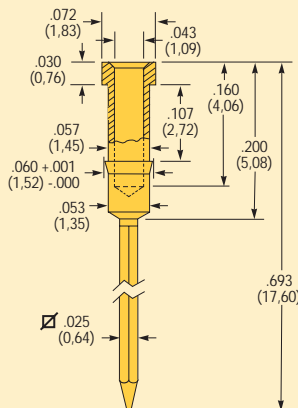

SIP-90-5

Materials: Brass, gold plated
 Mounting Hole Size: .057 (1,45)
 Applications: General interconnect.

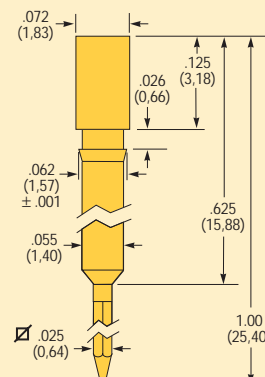

SIP-90-6

Materials: Brass, gold plated
 Mounting Hole Size: .057 (1,45)
 Applications: General interconnect.

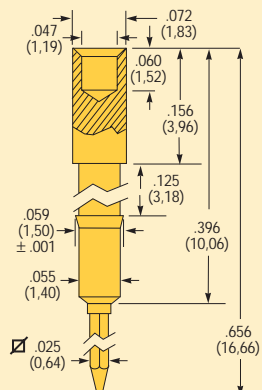

SIP-90-7

Materials: Brass, gold plated
 Mounting Hole Size: .0595 (1,51)
 Applications: General interconnect.

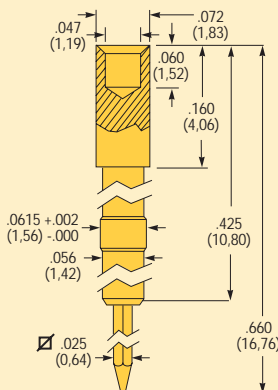

High Performance Contact Solutions for Semiconductor Test Packages

High density packages (BGA, CSPs, μ BGAs) continue their expanding popularity in today's modern PCBs. Increasing rise times and increasing signal density affect all areas of interconnection technology.

Test probes and Pogo[®] contacts continue to demonstrate their flexibility in newer demanding test/contact areas. Ostby Barton has years of experience in designing and producing high performance contacts needed in applications for: higher frequency test, low resistance measurements, high cycle life requirements, new solder technology processes, and other test connections (memory test, burn-in, handler apps, etc.)

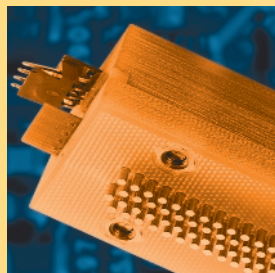
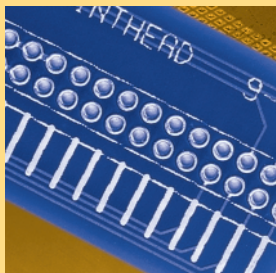
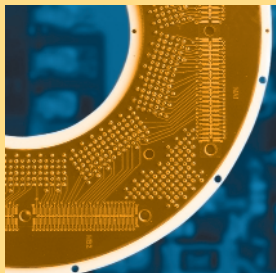

CSP4 CSP8 CSP5 CSP1-1.27

Double Ended Performance Pogo® Contacts for BGA, CSP, LGA and PGA Test Applications

ECT offers a wide variety of Double-Ended Pogos® on pitches ranging from .4 mm to 1.27 mm. Various length options also provides drop-in replacement capability for most competitor probes.

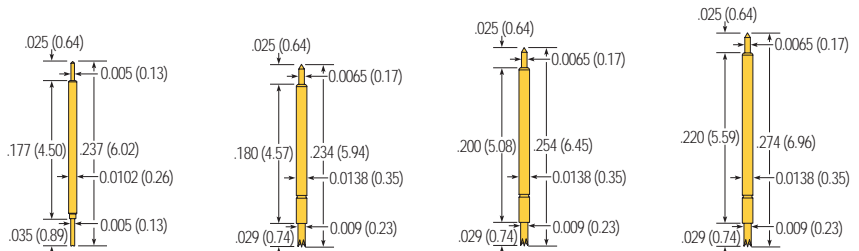

Specifications	CSP4	CSP5-18	CSP5-20	CSP5-22
Mechanical				
Pitch:	.4mm	.5mm	.5mm	.5mm
Recommended Mounting Centers:	.016 (0,40)	.020 (0,50)	.020 (0,50)	.020 (0,50)
Full Travel:	.025 (0,64)	.025 (0,64)	.025 (0,64)	.025 (0,64)
Recommended Travel:	.020 (0,51)	.020 (0,51)	.020 (0,51)	.020 (0,51)
Test Height:	.217 (5,51)	.214 (5,44)	.234 (5,94)	.254 (6,45)
Spring Force:	.85 (24,1g)	.7oz (19,8g)	.7oz (19,8g)	1.0oz (28,4g)
Overall Length:	.237 (6,02)	.234 (5,94)	.254 (6,45)	.274 (6,96)
Mechanical Life:	250,000 cycles	500,000 cycles	500,000 cycles	500,000 cycles
Materials and Finishes				
Plunger End (long extension)	BeCu or Steel	BeCu or Steel	BeCu or Steel	BeCu or Steel
Terminal End (short Extension)	BeCu or Steel	BeCu or Steel	BeCu or Steel	BeCu or Steel
Barrel:	Hard Gold over Nickel Phosphor Bronze Hard Gold over Nickel	Hard Gold over Nickel Phosphor Bronze Hard Gold over Nickel	Hard Gold over Nickel Phosphor Bronze Hard Gold over Nickel	Hard Gold over Nickel Phosphor Bronze Hard Gold over Nickel
Spring:	Music Wire/Gold Plate	Steel Alloy/Gold Plate	Steel Alloy/Gold Plate	Music Wire/Gold Plate
Environmental				
Maximum Operating Temperature:	105°C	155°C	155°C	105°C
Electrical				
Average DC Resistance:**	<100mΩ	<100mΩ	<100mΩ	<100mΩ
Current Capacity:	2A	2A	2A	2A
Self Inductance (Ls):	1.71nH	1.5nH*	1.65nH*	1.79nH
Capacitance (Cc):	.58pF	.63pF*	.69pF*	.75pF
Bandwidth @ -1dB:	6.8GHz	8.13GHz*	7.4GHz*	6.8GHz

B-TIP PLUNGER-DUT (ALL CSP PROBES)

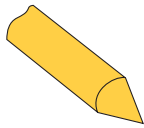

L-TIP PLUNGER-DUT (ALL CSP PROBES)

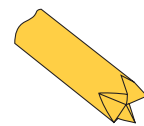

ORDERING INFORMATION CSP5

Example: CSP5-20LCBC

Model Number: CSP5-20L C B C

Barrel Length:

- 18 = .180
- 20 = .200
- 22 = .220

Plunger Tip Style:

- B, L

Plunger Material:

- C = BeCu
- S = Steel

Terminal Tip Style:

- B, L

Terminal Material:

- C = BeCu
- S = Steel

CSP8

Example: CSP8-25BSBS

Model Number: CSP8-25B S B S

Barrel Length:

- 15 = .150
- 20 = .200
- 25 = .250

Plunger Tip Style:

- B, L

Plunger Material:

- C = BeCu
- S = Steel

Terminal Tip Style:

- B, L

Terminal Material:

- C = BeCu
- S = Steel

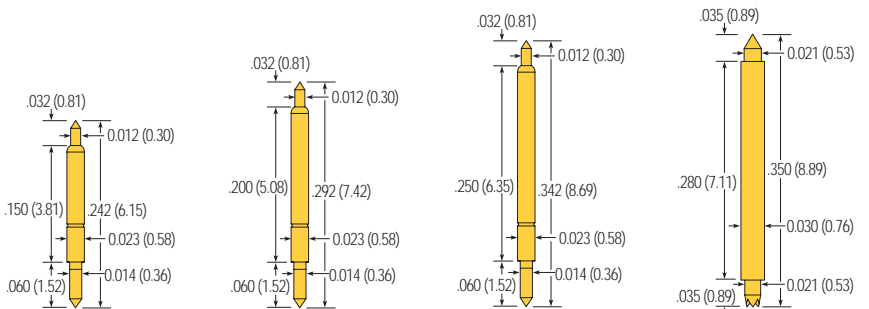

Specifications	CSP8-15	CSP8-20	CSP8-25	CSP1-1.27
Mechanical				
Pitch:	.8mm	.8mm	.8mm	1.0 - 1.27mm
Recommended Mounting Centers:	.0315 (0,80)	.0315 (0,80)	.0315 (0,80)	.039 (1,0) / .050 (1,27)
Full Travel:	.040 (1,02)	.040 (1,02)	.040 (1,02)	.040 (1,02)
Recommended Travel:	.030 (0,76)	.030 (0,76)	.030 (0,76)	.035 (0,89)
Test Height:	.212 (5,38)	.262 (6,65)	.312 (7,92)	.315 (8,0)
Spring Force:	1.1oz (31,2g)	1.1oz (31,2g)	1.1oz (31,2g)	2.0oz (56,7g)
Overall Length:	.242 (6,15)	.292 (7,42)	.342 (8,69)	.350 (8,89)
Mechanical Life:	500,000 cycles	500,000 cycles	500,000 cycles	500,000 cycles
Materials and Finishes				
Plunger End (long extension)	BeCu or Steel	BeCu or Steel	BeCu or Steel	BeCu
Terminal End (short Extension)	BeCu or Steel	BeCu or Steel	BeCu or Steel	BeCu
Barrel:	Hard Gold over Nickel Phosphor Bronze Hard Gold over Nickel	Hard Gold over Nickel Phosphor Bronze Hard Gold over Nickel	Hard Gold over Nickel Phosphor Bronze Hard Gold over Nickel	Hard Gold over Nickel Phosphor Bronze Hard Gold over Nickel
Spring:	Steel Alloy/Gold Plate	Steel Alloy/Gold Plate	Steel Alloy/Gold Plate	Steel Alloy/Gold Plate
Environmental				
Maximum Operating Temperature:	155°C	155°C	155°C	155°C
Electrical				
Average DC Resistance:**	<100mΩ	<100mΩ	<100mΩ	<50mΩ
Current Capacity:	3A	3A	3A	5A
Self Inductance (Ls):	1.23nH*	1.52nH*	1.81nH	3.1nH
Capacitance (Cc):	.65pF*	.81pF*	.96pF	.95pF
Bandwidth @ -1dB:	9.23GHz*	7.45GHz*	5.25GHz	3.8GHz

Consult factory for availability.

*Estimated

**DC Resistance measured contacting a clean gold plated surface on both probe tips.

BGA/PGA, LGA Applications

SOIC Package Test Contacts

The following assortment of Pogo contacts has been carefully selected from numerous successful solutions for high performance testing. Many have been used in test sockets for high speed CPU and memory BGA assemblies.

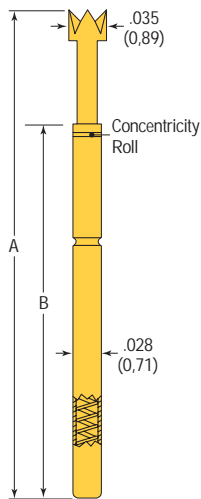

BGA & PGA Crown Head

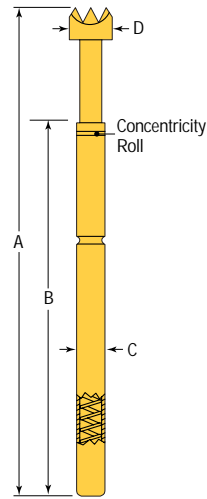

BGA & PGA Serrated Head

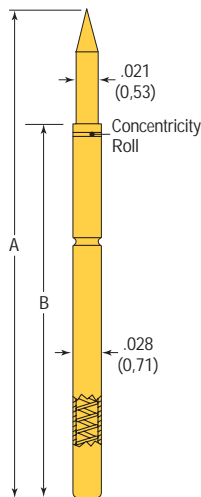

LGA Spear Point

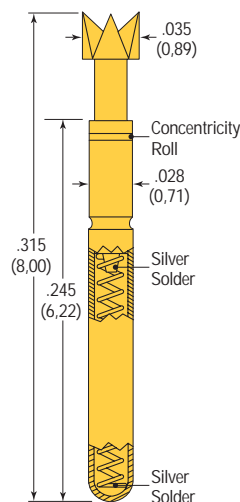

BGA

RECEPTACLES

BGR28-3

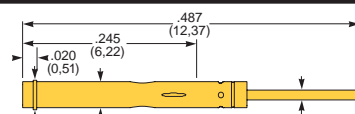

BGR28-DE

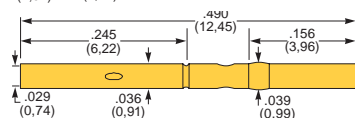

BGR28-S

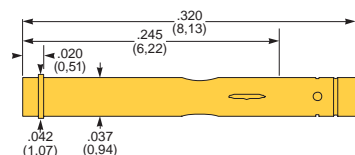

Consult factory for availability.

SPECIFICATIONS

BGA & PGA Crown Heads

Model Number	BGP28BL35ST	BGP28SL35ST	BGP28BL35LT	BGP28SL35LT
A: Overall Length	.315 (8,00)	.315 (8,00)	.470 (11,94)	.470 (11,94)
B: Barrel Length	.245 (6,22)	.245 (6,22)	.360 (9,14)	.360 (9,14)
Recommended Working Travel	.040 (1,02)	.040 (1,02)	.053 (1,35)	.053 (1,35)
Full Travel	.040 (1,02)	.040 (1,02)	.080 (2,03)	.080 (2,03)
Spring Pressure at Working Travel	2.0 OZ (57g)	2.0 OZ (57g)	2.0 OZ (57g)	1.6 OZ (45g)
Spring Material	BEUC	302 S.S.	BEUC	302 S.S.
Test Centers	.050 (1,27)			
Mechanical Life (Cycles)	> 25,000			
Electrical Current Rating (Static Conditions)	2-3 AMPS			
Electrical Average Resistance (mOHMS)	<50			

BGA & PGA Serrated Heads

Model Number	BGP28BHST	BGP28SHST	BGP28MHST	BGP28BHST
A: Overall Length	.295 (7,49)	.315 (8,00)	.470 (11,94)	.580 (14,73)
B: Barrel Length	.225 (5,72)	.245 (6,22)	.360 (9,14)	.470 (11,94)
C: Body Diameter	.028 (0,71)	.028 (0,71)	.028 (0,71)	.027 (0,69)
D: Head Diameter	.040 (1,02)	.040 (1,02)	.040 (1,02)	.035 (0,89)
Recommended Working Travel	.040 (1,02)	.040 (1,02)	.053 (1,35)	.075 (1,90)
Full Travel	.040 (1,02)	.040 (1,02)	.080 (2,03)	.075 (1,90)
Spring Pressure at Working Travel	2.0 OZ (57g)	2.0 OZ (57g)	2.1 OZ (60g)	2.5 OZ (71g)
Spring Material	BEUC	302 S.S.	Music Wire	BEUC
Test Centers	.050 (1,27)			
Mechanical Life (Cycles)	> 25,000			
Electrical Current Rating (Static Conditions)	2-3 AMPS			
Electrical Average Resistance (mOHMS)	<50			

LGA Spear Points

Model Number	LGP28BBST	LGP28SBST	LGP28BBLT	LGP28SBLT
A: Overall Length	.315 (8,00)	.315 (8,00)	.470 (11,94)	.470 (11,94)
B: Barrel Length	.245 (6,22)	.245 (6,22)	.360 (9,14)	.360 (9,14)
Recommended Working Travel	.040 (1,02)	.040 (1,02)	.053 (1,35)	.053 (1,35)
Full Travel	.040 (1,02)	.040 (1,02)	.080 (2,03)	.080 (2,03)
Spring Pressure at Working Travel	2.0 OZ (57g)	2.0 OZ (57g)	2.0 OZ (57g)	2.0 OZ (57g)
Spring Material	BEUC	302 S.S.	BEUC	302 S.S.
Test Centers	.050 (1,27)			
Mechanical Life (Cycles)	> 25,000			
Electrical Current Rating (Static Conditions)	2-3 AMPS			
Electrical Average Resistance (mOHMS)	<50			

This series can also be used as a "Ground Probe"

BGA

Model Number	BGP28BL35ST-S
Test Centers	.050 (1,27)
Recommended Working Travel	.040 (1,02)
Full Travel	.040 (1,02)
Spring Pressure at Working Travel	2.0 OZ (57g)
Mechanical Life (Cycles)	> 25,000
Electrical Current Rating (Static Conditions)	2-3 Amps
Electrical Average Resistance (mOHMS)	< 50

Cyclo Soldered Construction

BGA/PGA Various

Special Contacts, Handler Interface Contacts, Double-Ended Fine Pitch Contacts

For Discrete IC testing, BGA and PGA Contacts, and DUT Ring, for applications that require high performance interconnections.

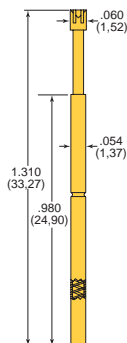

PGA OR OTHER PIN APPLICATIONS

Model Number	PIN54SG-1
Test Centers	.100 (2,54)
Recommended Working Travel	.166 (4,22)
Full Travel	.250 (6,35)
Spring Pressure At Working Travel	6.3 OZ (179g)
Mechanical Life (Cycles)	> 25,000
Electrical Current Rating (Static Conditions)	2-3 Amps
Electrical Average Resistance (mOHMS)	< 50
Uses Standard SR54 Receptacles	

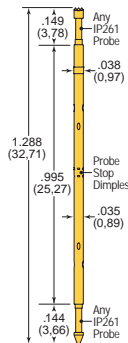

HANDLER INTERFACE PROBE / DOUBLE ENDER*

Model Number	DER28-IP261
Test Centers	.050 (1,27)
Recommended Working Travel (Each End)	.067 (1,70)
Full Travel (Each End)	.100 (2,54)
Spring Pressure At Working Travel	2.8 OZ (79g)
Mechanical Life (Cycles)	> 1,000,000
Electrical Current Rating (Static Conditions)	3 Amps
Electrical Average Resistance (mOHMS)	< 35
Recommended Hole Size	.036 Dia (#64 Drill)
*Probe not included, unless specified.	

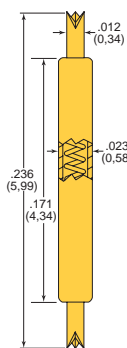

DOUBLE ENDED FINE PITCH CONTACTS

Model Number	BGP23U12-DE
Test Centers	.030 (0,762)
Recommended Working Travel	.030 (0,76)
Full Travel	.040 (1,02)
Spring Pressure At Working Travel	1.5 OZ (43g)
Mechanical Life (Cycles)	> 25,000
Electrical Current Rating (Static Conditions)	2-3 Amps
Electrical Average Resistance (mOHMS)	< 50

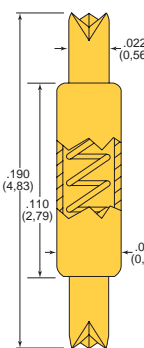

Model Number	BGP36U22-DE
Test Centers	.050 (1,27)
Recommended Working Travel	.030 (0,76)
Full Travel	.040 (1,02)
Spring Pressure At Working Travel	1.5 OZ (43g)
Mechanical Life (Cycles)	> 25,000
Electrical Current Rating (Static Conditions)	2-3 Amps
Electrical Average Resistance (mOHMS)	< 50
Large Plunger Dia Enables Contact To Offset Ball Locations	

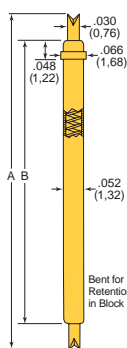

Model Number	BGP52L30-DE-SV	BGP52L30-DE-LV
A: Overall Length	.576 (14,63)	.876 (22,25)
B: Barrel Length	.436 (11,07)	.736 (18,69)
Recommended Working Travel	.093 (2,36)	.093 (2,36)
Full Travel	.140 (3,56)	.140 (3,56)
Spring Pressure at Working Travel	1.9 OZ (54g)	2.0 OZ (57g)
Test Centers	.100 (2,54)	.100 (2,54)
Mechanical Life (Cycles)	> 25,000	> 25,000
Electrical Current Rating (Static Conditions)	2-3 Amps	2-3 Amps
Electrical Average Resistance (mOHMS)	< 50	< 50

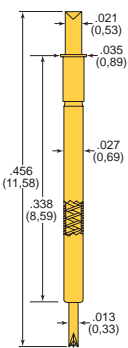

Model Number	BGP27G21-DE
Test Centers	.050 (1,27)
Recommended Working Travel	.040 (1,02)
Full Travel	.080 (2,03)
Spring Pressure At Working Travel	1.4 OZ (40g)
Mechanical Life (Cycles)	> 25,000
Electrical Current Rating (Static Conditions)	2-3 Amps
Electrical Average Resistance (mOHMS)	< 50

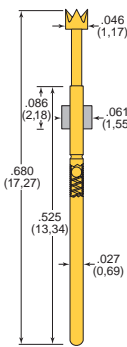

Model Number	BGP27L46-INS
Test Centers	.050 (1,27)
Recommended Working Travel	.100 (2,54)
Full Travel	.115 (2,92)
Spring Pressure At Working Travel	2.9 OZ (82g)
Mechanical Life (Cycles)	> 25,000
Electrical Current Rating (Static Conditions)	2-3 Amps
Electrical Average Resistance (mOHMS)	< 50
Insulated Ring:	Ultem

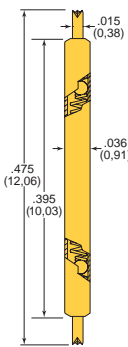

Model Number	BGP36U15-DE
Test Centers	.050 (1,27)
Recommended Working Travel	.060 (15,24)
Full Travel	.080 (2,03)
Spring Pressure At Working Travel	2.5 OZ (71g)
Mechanical Life (Cycles)	> 25,000
Electrical Current Rating (Static Conditions)	2-3 Amps
Electrical Average Resistance (mOHMS)	< 50
Double Bias Ball	

Consult factory for availability.

Tools



Crimp Pliers

Model #900*

Interchangeable Crimp Plier Locators

Model #	Receptacle Series
CL20	SR20
CL261	SR261
CL27	SR27
CL31	HPR72
CL40	SR40
CL54	SR54
CL541	SR541
CL80	SR80

* Operating instructions are included with each plier ordered.

Specifications subject to change without notice. Drawings not to scale. Optional tip styles, spring pressures, and materials available, contact factory for more information.



Receptacle Insertion Tools

Model #	Mounting Height	Receptacle Series
T20-0	Flush	SR20
T261-0	Flush	SR261
T27-0	Flush	SR27
AT31	Flush-.285	HPR72 HPR72W
ARIT40	Flush-.125	SR40
ARIT40	.160-.220	LR40 LTR-1W
ARIT54	Flush-.125"	SR541
ARIT54	Flush-.220"	SR54 SPR25W
T80-0	Flush	SR80
T93-0	Flush	SR93
T125-0	Flush	SR125
MRT54-005	.005 (0,13)	MR54
MRT554-005	.005 (0,13)	MR554

Adjustable Tool (ARIT) Instructions

1. Loosen set screws.
2. Rotate thimble to desired receptacle mounting height.
3. Lock both set screws.

Miscellaneous Insertion Tools

Model #	Description
FIT-1	Quick Connect™ insertion tool for SR28-4, SR31-4
PIT-261	Probe insertion tool for IP261 Series
PIE-54	Probe insertion and extraction tool for 100 mil center headed test probes



Maintenance Brushes

Model #	Description
MB-1	Brass bristle brush (4-1/4" x 2-1/2")
MB-2	4 row brass brush (3-1/4" x 1-1/8")
MB-3	Nylon brush (6-1/4")



Receptacle Installation

The receptacle is inserted into the drilled hole and tapped into place using a plastic mallet and a receptacle insertion tool. Several "taps" (3-5) with the mallet is recommended to provide maximum receptacle retention. Epoxy is not required. The receptacle is held in place by the press ring, which collapses into the hole during insertion, forming a tight fit.

While some insertion tools are designed to mount the receptacles flush with the probe plate, the ARIT series (Adjustable Tool) allows various mounting heights as required by the test fixture manufacturer. For instance, many users of the Pogo-25 long stroke series typically mount them .220" (5.59 mm) above the surface. The press ring is positioned for maximum retention in probe plates that are 3/8 inch thick or more. If the probe plate is too thin, the receptacle may fall through during insertion. In this case you can drill a smaller hole and use the press ring as a stop. However, you will need to secure receptacle with epoxy.

Once the receptacle is installed, insert the probe until the top of the probe barrel is flush with the top of the receptacle. The probe is held in place with 4 retention detents.



Ostby Barton
A Division of Everett
Charles Technologies
487 Jefferson Boulevard
Warwick, RI 02886
Tel: (401) 739-7310
Fax: (401) 732-4937
Internet: ectinfo.com

DOVER A Dover Company

8018-8-03-156